



Classic 1

Classic Collection has every length, width and height imaginable in every color.

CHOICES

- a) Colors – We'll build in any manufacturer's laminate, any color, any style.
- b) Customization – We create one-of-a-kind items to make your installation complete.
- c) Single Source – Get all your furniture through one source. We have desk, workstations, lecterns, study carrels, & conference tables. You name it, we build it.

FLEXIBILITY

- a) Modularity – Worksurfaces up to 120" long. Pedestals for all types of storage
- b) Custom Fit – For smaller personal spaces to the wide open range. Surfaces can be cut to length to efficiently fit the space.
- c) Growth – The smart way to grow business. Start out with a few pieces. Then add a few more.

FUNCTIONALITY

- a) Adaptable Edges – Straight edges abut easily for smooth continuous worksurfaces.
- b) Wire Management – Lots of grommets to route cords. For helpful alternative, order without back panel for complete wire access.
- c) Shapes – Lots of shapes to choose from. Shapes for interaction. Shapes for private meetings. Shapes to support technology.

DURABILITY

- a) Durable Edges – Won't scratch, nick or ding. Withstands even the toughest days on the job.
- b) HPL Vertical Surfaces – Surface resist nicks and scratches to battle wayward mobile pedestals.
- c) Easy to Clean – Just wipe with a damp cloth or mild household cleaner.



Classic Collection



Edge

L.U.I.+PLUS

The Classic Collection Desk Specifications

- Top & End Panels** 1 1/8" particle board covered on all surfaces with a high pressure laminate.

- Front End Panels** 3/4" particle board covered on exterior surfaces with high pressure laminate.

- Drawers** All wood construction. All exposed surfaces covered with black vinyl. All drawers open by finger pulls, which is from the side.

- File Drawers** Mounted on full extension progressive slides. Metal suspension supplied for hanging file folders. Accommodates letter or legal size

- Box Drawers** Mounted on full extension progressive slides.

- Doors** All L.U.I.+PLUS Single and Double Door Storage Units, feature concealed hinges and touch latch opening for clean design and easy operation.

- Finishes** Standard Finishes by **FORMICA & WILSON ART**
10% upcharge for **NEVEMAR** and **PIONITE** laminates

- Leveling Glides** Supplied on all units. Glides are adjustable.

- Keying** Standard production is to random key all units.

- Keying Alike** Units that are needed keyed alike should be specified on order (NO UPCHARGE)

- Master Keying** Is available on any number of units up to 50 different keys with 1 master key. Master keying should be specified, upcharge \$51 (Master Keys are not shipped with furniture, but sent to ordering dealer or designated agent.)

Classic 2

NOTE: Any desk or return with a file drawer comes standard with lock.

Recessed Front Model

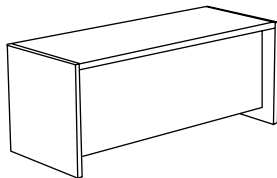

Flush Front Model

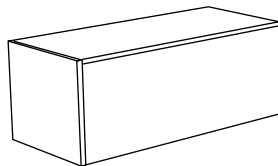

Recessed to Floor Model

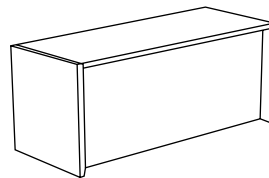



Classic Collection

Edge

Finishes

L.U.I.+PLUS Products are finished in high pressure laminate using the most modern machinery and techniques available.

Pricing

Prices shown in this price book reflects use of solid colors & woodgrains as many manufactured in standard "textured" finish

by: **WILSON ART** and **FORMICA**, add 10% upcharge for **NEVEMAR** and **PIONITE** laminates.

Specifying of two finishes on a unit may result in an upcharge. Consult factory. 1-800-638-4111

Other laminate manufacturers may be subject to an upcharge. Consult factory. 1-800-638-4111

Availability

Standard Finishes by **FORMICA & WILSON ART** are readily obtainable and expedite delivery.

Other manufacturer's material may delay shipment and result in an upcharge. Consult when specifying these materials.

Finish Types

Textured - The most commonly used material and the L.U.I.+PLUS standard. Unless otherwise noted, all products are available in this finish.

Gloss- A high sheen, glass-like highly susceptible to scratching. Consult factory upcharge. 1-800-638-4111

General Information

L.U.I.+PLUS does not manufacture laminate. You are requested to refer to laminate manufactures literature for complete specifications of product. All dimensions are approximate and through manufacturing process may vary.

EDGE TREATMENT

Self -Edge furniture is finished in laminate edge

VINYL BUMPER

To designate finish for bumper edge, put one of the below abbreviations with your finish selection on your purchase order.

- Dark Walnut**.....D01
- Medium Oak**.....D05
- Mahogany**.....D29
- Black**.....D03
- Light Grey**.....D31
- Putty**.....D04
- Cream**.....D20

FABRIC

Standard fabric selections for tackpanels are list below. There is no additional cost.

Guilford of Maine

- | | |
|----------------------------|------------------------|
| Bailey - Style 2229 | Hopscotch - Style 2823 |
| Grille - Style 2822 | Belgrade- Style 4052 |
| Orissa - Style 2818 | FR701-Style 2100 |
| Donegal Tweed - Style 3102 | |

To specify a fabric on your order please indicate group, group# and color#

Classic 3



Classic Collection

Edge

SERIES 200 - The Classic Collection Double Pedestal Desk

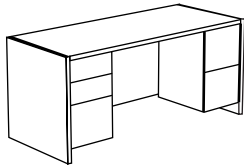

| D | W | Recessed Front # | Flush Front # | Recessed to Floor # | Zone 0 | Zone 1 | Zone 2 | WT |
|-----|-----|------------------|---------------|---------------------|---------|---------|---------|-----|
| 36" | 72" | 2L62-CD | 25L62-CD | 21L62-CD | \$2,534 | \$2,781 | \$2,930 | 465 |
| 30" | 72" | 2L02-CD | 25L02-CD | 21L02-CD | \$2,413 | \$2,660 | \$2,809 | 408 |
| 36" | 66" | 2L66-CD | 25L66-CD | 21L66-CD | \$2,413 | \$2,660 | \$2,809 | 420 |
| 30" | 66" | 2L06-CD | 25L06-CD | 21L06-CD | \$2,377 | \$2,623 | \$2,772 | 384 |
| 36" | 60" | 2L60-CD | 25L60-CD | 21L60-CD | \$2,401 | \$2,659 | \$2,796 | 378 |
| 30" | 60" | 2L00-CD | 25L00-CD | 21L00-CD | \$2,256 | \$2,502 | \$2,651 | 360 |

LEFT - Box/box/file - Pedestal

Locking

RIGHT - File/file - Pedestal

SHIPS FULLY ASSEMBLED

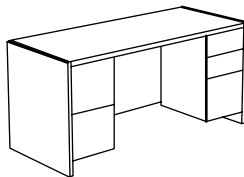

| D | W | Recessed Front # | Flush Front # | Recessed to Floor # | Zone 0 | Zone 1 | Zone 2 | WT |
|-----|-----|------------------|---------------|---------------------|---------|---------|---------|-----|
| 36" | 72" | 2L62-DC | 25L62-DC | 21L62-DC | \$2,534 | \$2,781 | \$2,930 | 465 |
| 30" | 72" | 2L02-DC | 25L02-DC | 21L02-DC | \$2,413 | \$2,660 | \$2,809 | 408 |
| 36" | 66" | 2L66-DC | 25L66-DC | 21L66-DC | \$2,413 | \$2,660 | \$2,809 | 420 |
| 30" | 66" | 2L06-DC | 25L06-DC | 21L06-DC | \$2,377 | \$2,623 | \$2,772 | 384 |
| 36" | 60" | 2L60-DC | 25L60-DC | 21L60-DC | \$2,401 | \$2,659 | \$2,796 | 378 |
| 30" | 60" | 2L00-DC | 25L00-DC | 21L00-DC | \$2,256 | \$2,502 | \$2,651 | 360 |

LEFT - File/file - Pedestal

Locking

RIGHT - Box/box/file - Pedestal

SHIPS FULLY ASSEMBLED

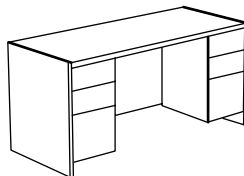

| D | W | Recessed Front # | Flush Front # | Recessed to Floor # | Zone 0 | Zone 1 | Zone 2 | WT |
|-----|-----|------------------|---------------|---------------------|---------|---------|---------|-----|
| 36" | 72" | 2L62-CC | 25L62-CC | 21L62-CC | \$2,534 | \$2,781 | \$2,930 | 465 |
| 30" | 72" | 2L02-CC | 25L02-CC | 21L02-CC | \$2,413 | \$2,660 | \$2,809 | 408 |
| 36" | 66" | 2L66-CC | 25L66-CC | 21L66-CC | \$2,413 | \$2,660 | \$2,809 | 420 |
| 30" | 66" | 2L06-CC | 25L06-CC | 21L06-CC | \$2,377 | \$2,623 | \$2,772 | 384 |
| 36" | 60" | 2L60-CC | 25L60-CC | 21L60-CC | \$2,401 | \$2,659 | \$2,796 | 378 |
| 30" | 60" | 2L00-CC | 25L00-CC | 21L00-CC | \$2,256 | \$2,502 | \$2,651 | 360 |

LEFT - Box/box/file - Pedestal

Locking

RIGHT - Box/box/file - Pedestal

SHIPS FULLY ASSEMBLED

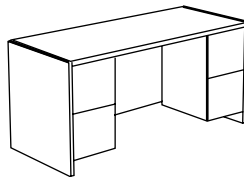

| D | W | Recessed Front # | Flush Front # | Recessed to Floor # | Zone 0 | Zone 1 | Zone 2 | WT |
|-----|-----|------------------|---------------|---------------------|---------|---------|---------|-----|
| 36" | 72" | 2L62-DD | 25L62-DD | 21L62-DD | \$2,534 | \$2,781 | \$2,930 | 465 |
| 30" | 72" | 2L02-DD | 25L02-DD | 21L02-DD | \$2,413 | \$2,660 | \$2,809 | 408 |
| 36" | 66" | 2L66-DD | 25L66-DD | 21L66-DD | \$2,413 | \$2,660 | \$2,809 | 420 |
| 30" | 66" | 2L06-DD | 25L06-DD | 21L06-DD | \$2,377 | \$2,623 | \$2,772 | 384 |
| 36" | 60" | 2L60-DD | 25L60-DD | 21L60-DD | \$2,401 | \$2,659 | \$2,796 | 378 |
| 30" | 60" | 2L00-DD | 25L00-DD | 21L00-DD | \$2,256 | \$2,502 | \$2,651 | 360 |

LEFT - File/file - Pedestal

Locking

RIGHT - File/file - Pedestal

SHIPS FULLY ASSEMBLED

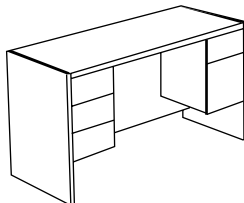

| D | W | Recessed Front # | Flush Front # | Recessed to Floor # | Zone 0 | Zone 1 | Zone 2 | WT |
|-----|-----|------------------|---------------|---------------------|---------|---------|---------|-----|
| 36" | 72" | 2M62-AB | 25M62-AB | 21M62-AB | \$2,280 | \$2,527 | \$2,675 | 444 |
| 30" | 72" | 2M02-AB | 25M02-AB | 21M02-AB | \$2,159 | \$2,406 | \$2,554 | 396 |
| 36" | 66" | 2M66-AB | 25M66-AB | 21M66-AB | \$2,244 | \$2,490 | \$2,640 | 408 |
| 30" | 66" | 2M06-AB | 25M06-AB | 21M06-AB | \$2,123 | \$2,370 | \$2,519 | 372 |
| 36" | 60" | 2M60-AB | 25M60-AB | 21M60-AB | \$2,147 | \$2,393 | \$2,542 | 366 |
| 30" | 60" | 2M00-AB | 25M00-AB | 21M00-AB | \$2,002 | \$2,249 | \$2,398 | 348 |

LEFT - Box/box/box - Pedestal

Locking

RIGHT - Box/file - Pedestal

SHIPS FULLY ASSEMBLED

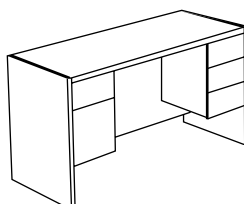

| D | W | Recessed Front # | Flush Front # | Recessed to Floor # | Zone 0 | Zone 1 | Zone 2 | WT |
|-----|-----|------------------|---------------|---------------------|---------|---------|---------|-----|
| 36" | 72" | 2M62-BA | 25M62-BA | 21M62-BA | \$2,280 | \$2,527 | \$2,675 | 444 |
| 30" | 72" | 2M02-BA | 25M02-BA | 21M02-BA | \$2,159 | \$2,406 | \$2,554 | 396 |
| 36" | 66" | 2M66-BA | 25M66-BA | 21M66-BA | \$2,244 | \$2,490 | \$2,640 | 408 |
| 30" | 66" | 2M06-BA | 25M06-BA | 21M06-BA | \$2,123 | \$2,370 | \$2,519 | 372 |
| 36" | 60" | 2M60-BA | 25M60-BA | 21M60-BA | \$2,147 | \$2,393 | \$2,542 | 366 |
| 30" | 60" | 2M00-BA | 25M00-BA | 21M00-BA | \$2,002 | \$2,249 | \$2,398 | 348 |

LEFT - Box/file - Pedestal

Locking

RIGHT - Box/box/box - Pedestal

SHIPS FULLY ASSEMBLED

Classic 4



Classic Collection

Edge

SERIES 200 - The Classic Collection Double Pedestal Desk

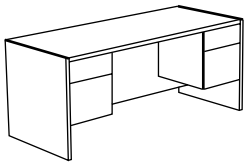

| D | W | Recessed Front # | Flush Front # | Recessed to Floor # | Zone 0 | Zone 1 | Zone 2 | WT |
|-----|-----|------------------|---------------|---------------------|---------|---------|---------|-----|
| 36" | 72" | 2M62-BB | 25M62-BB | 21M62-BB | \$2,280 | \$2,527 | \$2,675 | 444 |
| 30" | 72" | 2M02-BB | 25M02-BB | 21M02-BB | \$2,159 | \$2,406 | \$2,554 | 396 |
| 36" | 66" | 2M66-BB | 25M66-BB | 21M66-BB | \$2,244 | \$2,490 | \$2,640 | 408 |
| 30" | 66" | 2M06-BB | 25M06-BB | 21M06-BB | \$2,123 | \$2,370 | \$2,519 | 372 |
| 36" | 60" | 2M60-BB | 25M60-BB | 21M60-BB | \$2,147 | \$2,393 | \$2,542 | 366 |
| 30" | 60" | 2M00-BB | 25M00-BB | 21M00-BB | \$2,002 | \$2,249 | \$2,398 | 348 |

LEFT - Box/file - Pedestal

Locking

RIGHT - Box/file - Pedestal

SHIPS FULLY ASSEMBLED

SERIES 200 - The Classic Collection Single Pedestal Desk

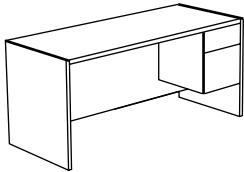

| D | W | Recessed Front # | Flush Front # | Recessed to Floor # | Zone 0 | Zone 1 | Zone 2 | WT |
|-----|-----|------------------|---------------|---------------------|---------|---------|---------|-----|
| 36" | 72" | 2M62-XB | 25M62-XB | 21M62-XB | \$1,821 | \$1,970 | \$2,119 | 390 |
| 36" | 66" | 2M66-XB | 25M66-XB | 21M66-XB | \$1,796 | \$1,946 | \$2,095 | 354 |
| 36" | 60" | 2M60-XB | 25M60-XB | 21M60-XB | \$1,700 | \$1,849 | \$1,998 | 312 |
| 30" | 72" | 2M02-XB | 25M02-XB | 21M02-XB | \$1,712 | \$1,862 | \$2,010 | 342 |
| 30" | 66" | 2M06-XB | 25M06-XB | 21M06-XB | \$1,687 | \$1,837 | \$1,986 | 318 |
| 30" | 60" | 2M00-XB | 25M00-XB | 21M00-XB | \$1,566 | \$1,716 | \$1,865 | 294 |
| 24" | 72" | 2M42-XB | 25M42-XB | 21M42-XB | \$1,518 | \$1,668 | \$1,817 | 249 |
| 24" | 66" | 2M46-XB | 25M46-XB | 21M46-XB | \$1,470 | \$1,620 | \$1,768 | 204 |
| 24" | 60" | 2M40-XB | 25M40-XB | 21M40-XB | \$1,398 | \$1,547 | \$1,696 | 174 |
| 24" | 48" | 2M48-XB | 25M48-XB | 21M48-XB | \$1,277 | \$1,426 | \$1,575 | 156 |

RIGHT - Box/file - Pedestal

SHIPS FULLY ASSEMBLED

Locking

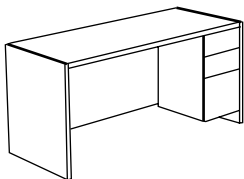

| D | W | Recessed Front # | Flush Front # | Recessed to Floor # | Zone 0 | Zone 1 | Zone 2 | WT |
|-----|-----|------------------|---------------|---------------------|---------|---------|---------|-----|
| 36" | 72" | 2L62-XC | 25L62-XC | 21L62-XC | \$2,063 | \$2,212 | \$2,361 | 390 |
| 36" | 66" | 2L66-XC | 25L66-XC | 21L66-XC | \$2,038 | \$2,188 | \$2,337 | 354 |
| 36" | 60" | 2L60-XC | 25L60-XC | 21L60-XC | \$1,929 | \$2,079 | \$2,228 | 312 |
| 30" | 72" | 2L02-XC | 25L02-XC | 21L02-XC | \$1,942 | \$2,091 | \$2,240 | 342 |
| 30" | 66" | 2L06-XC | 25L06-XC | 21L06-XC | \$1,905 | \$2,055 | \$2,204 | 318 |
| 30" | 60" | 2L00-XC | 25L00-XC | 21L00-XC | \$1,772 | \$1,922 | \$2,070 | 294 |
| 24" | 72" | 2L42-XC | 25L42-XC | 21L42-XC | \$1,712 | \$1,862 | \$2,010 | 249 |
| 24" | 66" | 2L46-XC | 25L46-XC | 21L46-XC | \$1,663 | \$1,813 | \$1,962 | 204 |
| 24" | 60" | 2L40-XC | 25L40-XC | 21L40-XC | \$1,591 | \$1,741 | \$1,889 | 174 |
| 24" | 48" | 2L48-XC | 25L48-XC | 21L48-XC | \$1,518 | \$1,668 | \$1,817 | 156 |

RIGHT - Box/box/file - Pedestal

SHIPS FULLY ASSEMBLED

Locking

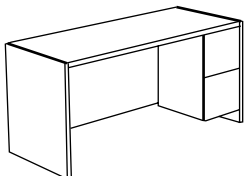

| D | W | Recessed Front # | Flush Front # | Recessed to Floor # | Zone 0 | Zone 1 | Zone 2 | WT |
|-----|-----|------------------|---------------|---------------------|---------|---------|---------|-----|
| 36" | 72" | 2L62-XD | 25L62-XD | 21L62-XD | \$2,063 | \$2,212 | \$2,361 | 390 |
| 36" | 66" | 2L66-XD | 25L66-XD | 21L66-XD | \$2,038 | \$2,188 | \$2,337 | 354 |
| 36" | 60" | 2L60-XD | 25L60-XD | 21L60-XD | \$1,929 | \$2,079 | \$2,228 | 312 |
| 30" | 72" | 2L02-XD | 25L02-XD | 21L02-XD | \$1,942 | \$2,091 | \$2,240 | 342 |
| 30" | 66" | 2L06-XD | 25L06-XD | 21L06-XD | \$1,905 | \$2,055 | \$2,204 | 318 |
| 30" | 60" | 2L00-XD | 25L00-XD | 21L00-XD | \$1,772 | \$1,922 | \$2,070 | 294 |
| 24" | 72" | 2L42-XD | 25L42-XD | 21L42-XD | \$1,712 | \$1,862 | \$2,010 | 249 |
| 24" | 66" | 2L46-XD | 25L46-XD | 21L46-XD | \$1,663 | \$1,813 | \$1,962 | 204 |
| 24" | 60" | 2L40-XD | 25L40-XD | 21L40-XD | \$1,591 | \$1,741 | \$1,889 | 174 |
| 24" | 48" | 2L48-XD | 25L48-XD | 21L48-XD | \$1,518 | \$1,668 | \$1,817 | 156 |

RIGHT - File/file - Pedestal

SHIPS FULLY ASSEMBLED

Locking

Classic 5



Classic Collection

Edge

SERIES 200 - The Classic Collection Single Pedestal Desk

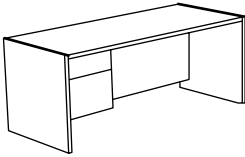

| D | W | Recessed Front # | Flush Front # | Recessed to Floor # | Zone 0 | Zone 1 | Zone 2 | WT |
|-----|-----|------------------|---------------|---------------------|---------|---------|---------|-----|
| 36" | 72" | 2M62-BX | 25M62-BX | 21M62-BX | \$1,821 | \$1,970 | \$2,119 | 390 |
| 36" | 66" | 2M66-BX | 25M66-BX | 21M66-BX | \$1,796 | \$1,946 | \$2,095 | 354 |
| 36" | 60" | 2M60-BX | 25M60-BX | 21M60-BX | \$1,700 | \$1,849 | \$1,998 | 312 |
| 30" | 72" | 2M02-BX | 25M02-BX | 21M02-BX | \$1,712 | \$1,862 | \$2,010 | 342 |
| 30" | 66" | 2M06-BX | 25M06-BX | 21M06-BX | \$1,687 | \$1,837 | \$1,986 | 318 |
| 30" | 60" | 2M00-BX | 25M00-BX | 21M00-BX | \$1,566 | \$1,716 | \$1,865 | 294 |
| 24" | 72" | 2M42-BX | 25M42-BX | 21M42-BX | \$1,518 | \$1,668 | \$1,817 | 249 |
| 24" | 66" | 2M46-BX | 25M46-BX | 21M46-BX | \$1,470 | \$1,620 | \$1,768 | 204 |
| 24" | 60" | 2M40-BX | 25M40-BX | 21M40-BX | \$1,398 | \$1,547 | \$1,696 | 174 |
| 24" | 48" | 2M48-BX | 25M48-BX | 21M48-BX | \$1,277 | \$1,426 | \$1,575 | 156 |

LEFT - Box/file - Pedestal

Locking

SHIPS FULLY ASSEMBLED

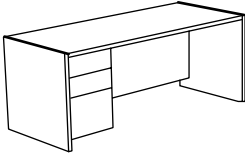

| D | W | Recessed Front # | Flush Front # | Recessed to Floor # | Zone 0 | Zone 1 | Zone 2 | WT |
|-----|-----|------------------|---------------|---------------------|---------|---------|---------|-----|
| 36" | 72" | 2L62-CX | 25L62-CX | 21L62-CX | \$2,063 | \$2,212 | \$2,361 | 390 |
| 36" | 66" | 2L66-CX | 25L66-CX | 21L66-CX | \$2,038 | \$2,188 | \$2,337 | 354 |
| 36" | 60" | 2L60-CX | 25L60-CX | 21L60-CX | \$1,929 | \$2,079 | \$2,228 | 312 |
| 30" | 72" | 2L02-CX | 25L02-CX | 21L02-CX | \$1,942 | \$2,091 | \$2,240 | 342 |
| 30" | 66" | 2L06-CX | 25L06-CX | 21L06-CX | \$1,905 | \$2,055 | \$2,204 | 318 |
| 30" | 60" | 2L00-CX | 25L00-CX | 21L00-CX | \$1,772 | \$1,922 | \$2,070 | 294 |
| 24" | 72" | 2L42-CX | 25L42-CX | 21L42-CX | \$1,712 | \$1,862 | \$2,010 | 249 |
| 24" | 66" | 2L46-CX | 25L46-CX | 21L46-CX | \$1,663 | \$1,813 | \$1,962 | 204 |
| 24" | 60" | 2L40-CX | 25L40-CX | 21L40-CX | \$1,591 | \$1,741 | \$1,889 | 174 |
| 24" | 48" | 2L48-CX | 25L48-CX | 21L48-CX | \$1,518 | \$1,668 | \$1,817 | 156 |

LEFT - Box/box/file - Pedestal

SHIPS FULLY ASSEMBLED

Locking

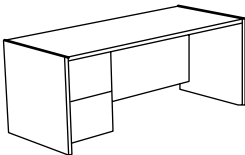

| D | W | Recessed Front # | Flush Front # | Recessed to Floor # | Zone 0 | Zone 1 | Zone 2 | WT |
|-----|-----|------------------|---------------|---------------------|---------|---------|---------|-----|
| 36" | 72" | 2L62-DX | 25L62-DX | 21L62-DX | \$2,063 | \$2,212 | \$2,361 | 390 |
| 36" | 66" | 2L66-DX | 25L66-DX | 21L66-DX | \$2,038 | \$2,188 | \$2,337 | 354 |
| 36" | 60" | 2L60-DX | 25L60-DX | 21L60-DX | \$1,929 | \$2,079 | \$2,228 | 312 |
| 30" | 72" | 2L02-DX | 25L02-DX | 21L02-DX | \$1,942 | \$2,091 | \$2,240 | 342 |
| 30" | 66" | 2L06-DX | 25L06-DX | 21L06-DX | \$1,905 | \$2,055 | \$2,204 | 318 |
| 30" | 60" | 2L00-DX | 25L00-DX | 21L00-DX | \$1,772 | \$1,922 | \$2,070 | 294 |
| 24" | 72" | 2L42-DX | 25L42-DX | 21L42-DX | \$1,712 | \$1,862 | \$2,010 | 249 |
| 24" | 66" | 2L46-DX | 25L46-DX | 21L46-DX | \$1,663 | \$1,813 | \$1,962 | 204 |
| 24" | 60" | 2L40-DX | 25L40-DX | 21L40-DX | \$1,591 | \$1,741 | \$1,889 | 174 |
| 24" | 48" | 2L48-DX | 25L48-DX | 21L48-DX | \$1,518 | \$1,668 | \$1,817 | 156 |

LEFT - File/file - Pedestal

SHIPS FULLY ASSEMBLED

Locking

Classic 6



Classic Collection

Edge

SERIES 200 - The Classic Collection Executive Returns / LEFT

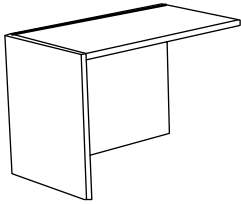

| D | W | Model# | Zone 0 | Zone 1 | Zone 2 | WT |
|-----|-----|----------|---------|---------|---------|-----|
| 20" | 54" | 2E54-OX | \$1,324 | \$1,426 | \$1,551 | 216 |
| 20" | 48" | 2E48-OX | \$1,131 | \$1,232 | \$1,358 | 186 |
| 20" | 42" | 2E42-OX | \$1,107 | \$1,209 | \$1,333 | 162 |
| 20" | 36" | 2E36-OX | \$1,082 | \$1,185 | \$1,309 | 138 |
| 24" | 54" | 24E54-OX | \$1,264 | \$1,365 | \$1,490 | 216 |
| 24" | 48" | 24E48-OX | \$1,191 | \$1,293 | \$1,418 | 186 |
| 24" | 42" | 24E42-OX | \$1,156 | \$1,257 | \$1,381 | 162 |
| 24" | 36" | 24E36-OX | \$1,131 | \$1,232 | \$1,358 | 138 |

LEFT - No Pedestal

SHIPS FULLY ASSEMBLED

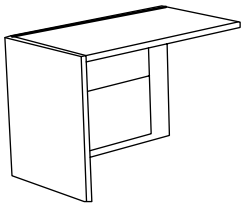

| D | W | Model# | Zone 0 | Zone 1 | Zone 2 | WT |
|-----|-----|----------|---------|---------|---------|-----|
| 20" | 54" | 2E54-BX | \$1,470 | \$1,571 | \$1,696 | 258 |
| 20" | 48" | 2E48-BX | \$1,409 | \$1,511 | \$1,635 | 222 |
| 20" | 42" | 2E42-BX | \$1,373 | \$1,474 | \$1,599 | 198 |
| 20" | 36" | 2E36-BX | \$1,361 | \$1,462 | \$1,587 | 174 |
| 24" | 54" | 24E54-BX | \$1,579 | \$1,680 | \$1,805 | 258 |
| 24" | 48" | 24E48-BX | \$1,518 | \$1,620 | \$1,744 | 222 |
| 24" | 42" | 24E42-BX | \$1,494 | \$1,595 | \$1,720 | 198 |
| 24" | 36" | 24E36-BX | \$1,458 | \$1,560 | \$1,684 | 174 |

LEFT - Box/file - Pedestal

Locking

SHIPS FULLY ASSEMBLED

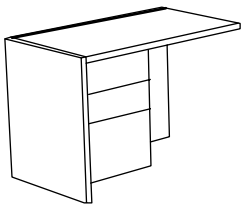

| D | W | Model# | Zone 0 | Zone 1 | Zone 2 | WT |
|-----|-----|----------|---------|---------|---------|-----|
| 20" | 54" | 2E54-CX | \$1,566 | \$1,669 | \$1,793 | 252 |
| 20" | 48" | 2E48-CX | \$1,494 | \$1,595 | \$1,720 | 232 |
| 20" | 42" | 2E42-CX | \$1,470 | \$1,571 | \$1,696 | 208 |
| 20" | 36" | 2E36-CX | \$1,433 | \$1,535 | \$1,660 | 198 |
| 24" | 54" | 24E54-CX | \$1,603 | \$1,704 | \$1,902 | 252 |
| 24" | 48" | 24E48-CX | \$1,554 | \$1,656 | \$1,781 | 232 |
| 24" | 42" | 24E42-CX | \$1,518 | \$1,620 | \$1,744 | 208 |
| 24" | 36" | 24E36-CX | \$1,494 | \$1,595 | \$1,720 | 198 |

LEFT - Box/box/file - Pedestal

Locking

SHIPS FULLY ASSEMBLED

Classic 7



Classic Collection

Edge

SERIES 200 - The Classic Collection Executive Returns / RIGHT

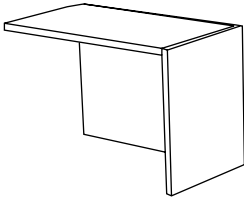

| D | W | Model# | Zone 0 | Zone 1 | Zone 2 | WT |
|-----|-----|----------|---------|---------|---------|-----|
| 20" | 54" | 2E54-XO | \$1,324 | \$1,426 | \$1,551 | 216 |
| 20" | 48" | 2E48-XO | \$1,131 | \$1,232 | \$1,358 | 186 |
| 20" | 42" | 2E42-XO | \$1,107 | \$1,209 | \$1,333 | 162 |
| 20" | 36" | 2E36-XO | \$1,082 | \$1,185 | \$1,309 | 138 |
| 24" | 54" | 24E54-XO | \$1,264 | \$1,365 | \$1,490 | 216 |
| 24" | 48" | 24E48-XO | \$1,191 | \$1,293 | \$1,418 | 186 |
| 24" | 42" | 24E42-XO | \$1,156 | \$1,257 | \$1,381 | 162 |
| 24" | 36" | 24E36-XO | \$1,131 | \$1,232 | \$1,358 | 138 |

RIGHT - No Pedestal
SHIPS FULLY ASSEMBLED

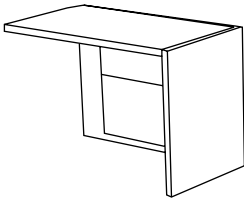

| D | W | Model# | Zone 0 | Zone 1 | Zone 2 | WT |
|-----|-----|----------|---------|---------|---------|-----|
| 20" | 54" | 2E54-XB | \$1,470 | \$1,571 | \$1,696 | 258 |
| 20" | 48" | 2E48-XB | \$1,409 | \$1,511 | \$1,635 | 222 |
| 20" | 42" | 2E42-XB | \$1,373 | \$1,474 | \$1,599 | 198 |
| 20" | 36" | 2E36-XB | \$1,361 | \$1,462 | \$1,587 | 174 |
| 24" | 54" | 24E54-XB | \$1,579 | \$1,680 | \$1,805 | 258 |
| 24" | 48" | 24E48-XB | \$1,518 | \$1,620 | \$1,744 | 222 |
| 24" | 42" | 24E42-XB | \$1,494 | \$1,595 | \$1,720 | 198 |
| 24" | 36" | 24E36-XB | \$1,458 | \$1,560 | \$1,684 | 174 |

RIGHT - Box/file - Pedestal
Locking
SHIPS FULLY ASSEMBLED

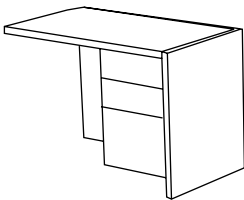

| D | W | Model# | Zone 0 | Zone 1 | Zone 2 | WT |
|-----|-----|----------|---------|---------|---------|-----|
| 20" | 54" | 2E54-XC | \$1,566 | \$1,669 | \$1,793 | 252 |
| 20" | 48" | 2E48-XC | \$1,494 | \$1,595 | \$1,720 | 232 |
| 20" | 42" | 2E42-XC | \$1,470 | \$1,571 | \$1,696 | 208 |
| 20" | 36" | 2E36-XC | \$1,433 | \$1,535 | \$1,660 | 198 |
| 24" | 54" | 24E54-XC | \$1,603 | \$1,704 | \$1,902 | 252 |
| 24" | 48" | 24E48-XC | \$1,554 | \$1,656 | \$1,781 | 232 |
| 24" | 42" | 24E42-XC | \$1,518 | \$1,620 | \$1,744 | 208 |
| 24" | 36" | 24E36-XC | \$1,494 | \$1,595 | \$1,720 | 198 |

RIGHT - Box/box/file - Pedestal
Locking
SHIPS FULLY ASSEMBLED

Classic 8



Classic Collection

Edge

SERIES 200 - The Classic Collection Filler Tops Between Desks & Credenza - Non - Handed

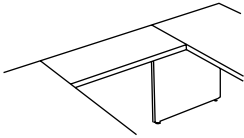

| D | W | Model# | Zone 0 | Zone 1 | Zone 2 | WT |
|-----|-----|--------|--------|--------|--------|----|
| 20" | 48" | 2ET08 | \$345 | \$386 | \$437 | 54 |
| 20" | 42" | 2ET02 | \$321 | \$362 | \$414 | 46 |
| 20" | 36" | 2ET06 | \$284 | \$325 | \$377 | 36 |
| 24" | 48" | 2ET48 | \$381 | \$422 | \$474 | 54 |
| 24" | 42" | 2ET42 | \$356 | \$397 | \$450 | 46 |
| 24" | 36" | 2ET46 | \$333 | \$374 | \$426 | 38 |

29" H WITHOUT back panel
SHIPS KD

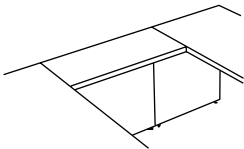

| D | W | Model# | Zone 0 | Zone 1 | Zone 2 | WT |
|-----|-----|--------|--------|--------|--------|----|
| 20" | 48" | 2ETF08 | \$732 | \$821 | \$874 | 54 |
| 20" | 42" | 2ETF02 | \$756 | \$797 | \$849 | 46 |
| 20" | 36" | 2ETF06 | \$732 | \$773 | \$825 | 36 |
| 24" | 48" | 2ETF48 | \$828 | \$869 | \$921 | 54 |
| 24" | 42" | 2ETF42 | \$805 | \$821 | \$901 | 46 |
| 24" | 36" | 2ETF46 | \$793 | \$834 | \$886 | 38 |

29" H WITH back panel
SHIPS KD

SERIES 200 - Corner Units - 42" D x 42"W x 29"H - Use 24"D Return

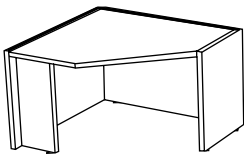

| W | Model# | Zone 1 | Zone 2 | Zone 3 | WT |
|-----|---------|---------|---------|---------|-----|
| 42" | 2CT42L9 | \$1,156 | \$1,197 | \$1,248 | 190 |

NOTE: Use with LEFT Return
SHIPS FULLY ASSEMBLED

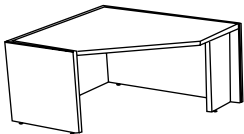

| W | Model# | Zone 1 | Zone 2 | Zone 3 | WT |
|-----|---------|---------|---------|---------|-----|
| 42" | 2CT42R9 | \$1,156 | \$1,197 | \$1,248 | 190 |

NOTE: Use with RIGHT Return
SHIPS FULLY ASSEMBLED

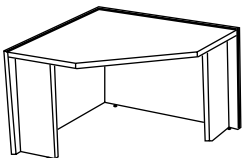

| W | Model# | Zone 1 | Zone 2 | Zone 3 | WT |
|-----|----------|---------|---------|---------|-----|
| 42" | 2CT42RL9 | \$1,156 | \$1,197 | \$1,248 | 190 |

NOTE: Use with LEFT & RIGHT Return
SHIPS FULLY ASSEMBLED

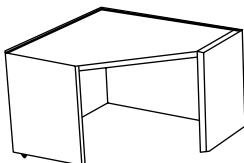

| W | Model# | Zone 1 | Zone 2 | Zone 3 | WT |
|-----|----------|---------|---------|---------|-----|
| 42" | 2CT42FS9 | \$1,156 | \$1,197 | \$1,248 | 190 |

NOTE: This unit is freestanding
SHIPS FULLY ASSEMBLED

Classic 9



Classic Collection



Edge

SERIES 200 - The Classic Collection Executive Credenzas

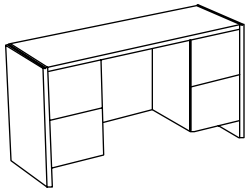

| D | W | Recessed Front # | Flush Front # | Zone 0 | Zone 1 | Zone 2 | WT |
|-----|-----|------------------|---------------|---------|---------|---------|-----|
| 22" | 72" | 2L72-DXD | 25L72-DXD | \$1,987 | \$2,141 | \$2,270 | 270 |
| 22" | 60" | 2L60-DXD | 25L60-DXD | \$1,924 | \$2,080 | \$2,208 | 259 |

Left/File/file - Pedestal
Right/File/file - Pedestal

Kneespace
Locking

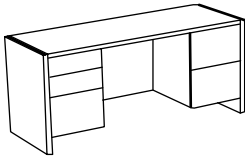

| D | W | Recessed Front # | Flush Front # | Zone 0 | Zone 1 | Zone 2 | WT |
|-----|-----|------------------|---------------|---------|---------|---------|-----|
| 22" | 72" | 2L72-CXD | 25L72-CXD | \$1,987 | \$2,141 | \$2,270 | 270 |
| 22" | 60" | 2L60-CXD | 25L60-CXD | \$1,924 | \$2,080 | \$2,208 | 259 |

Locking
LEFT - Box/file/file - Pedestal
RIGHT - File/file - Pedestal

Kneespace
SHIPS FULL ASSEMBLED

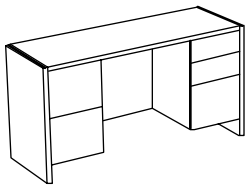

| D | W | Recessed Front # | Flush Front # | Zone 0 | Zone 1 | Zone 2 | WT |
|-----|-----|------------------|---------------|---------|---------|---------|-----|
| 22" | 72" | 2L72-DXC | 25L72-DXC | \$1,987 | \$2,141 | \$2,270 | 270 |
| 22" | 60" | 2L60-DXC | 25L60-DXC | \$1,924 | \$2,080 | \$2,208 | 259 |

Locking
RIGHT - Box/file/file - Pedestal
LEFT - File/file - Pedestal

Kneespace
SHIPS FULL ASSEMBLED

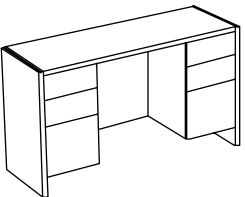

| D | W | Recessed Front # | Flush Front # | Zone 0 | Zone 1 | Zone 2 | WT |
|-----|-----|------------------|---------------|---------|---------|---------|-----|
| 22" | 72" | 2L72-CXC | 25L72-CXC | \$1,987 | \$2,141 | \$2,270 | 270 |
| 22" | 60" | 2L60-CXC | 25L60-CXC | \$1,924 | \$2,080 | \$2,208 | 259 |

Locking
RIGHT - Box/file/file - Pedestal
LEFT - Box/file/file - Pedestal

Kneespace
SHIPS FULL ASSEMBLED

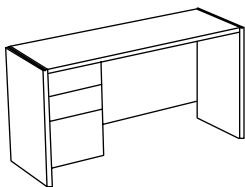

| D | W | Recessed Front # | Flush Front # | Zone 0 | Zone 1 | Zone 2 | WT |
|-----|-----|------------------|---------------|---------|---------|---------|-----|
| 22" | 72" | 2L72-CXX | 25L72-CXX | \$1,688 | \$1,842 | \$1,971 | 170 |
| 22" | 60" | 2L60-CXX | 25L60-CXX | \$1,576 | \$1,730 | \$1,859 | 159 |

Locking
LEFT - Box/file/file - Pedestal

Kneespace
SHIPS FULL ASSEMBLED

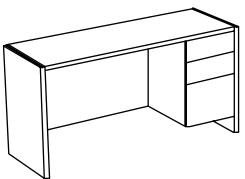

| D | W | Recessed Front # | Flush Front # | Zone 0 | Zone 1 | Zone 2 | WT |
|-----|-----|------------------|---------------|---------|---------|---------|-----|
| 22" | 72" | 2L72-XXC | 25L72-XXC | \$1,688 | \$1,842 | \$1,971 | 170 |
| 22" | 60" | 2L60-XXC | 25L60-XXC | \$1,576 | \$1,730 | \$1,859 | 159 |

Locking
RIGHT - Box/file/file - Pedestal

Kneespace
SHIPS FULL ASSEMBLED

Classic 10



Classic Collection



Edge

SERIES 200 - The Classic Collection Executive Credenzas

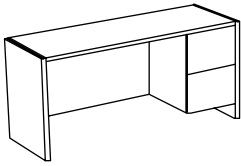

| D | W | Recessed Front # | Flush Front # | Zone 0 | Zone 1 | Zone 2 | WT |
|-----|-----|------------------|---------------|---------|---------|---------|-----|
| 22" | 72" | 2L72-XXD | 25L72-XXD | \$1,688 | \$1,842 | \$1,971 | 170 |
| 22" | 60" | 2L60-XXD | 25L60-XXD | \$1,576 | \$1,730 | \$1,859 | 159 |

Locking
RIGHT - File/file - Pedestal
 Kneespace
SHIPS FULL ASSEMBLED

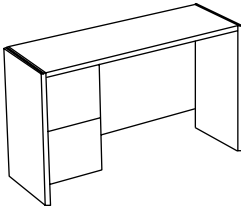

| D | W | Recessed Front # | Flush Front # | Zone 0 | Zone 1 | Zone 2 | WT |
|-----|-----|------------------|---------------|---------|---------|---------|-----|
| 22" | 72" | 2L72-DXX | 25L72-DXX | \$1,688 | \$1,842 | \$1,971 | 170 |
| 22" | 60" | 2L60-DXX | 25L60-DXX | \$1,576 | \$1,730 | \$1,859 | 159 |

Locking
LEFT - File/file - Pedestal
 Kneespace
SHIPS FULL ASSEMBLED

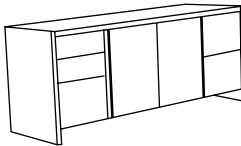

| D | W | Recessed Front # | Flush Front # | Zone 0 | Zone 1 | Zone 2 | WT |
|-----|-----|------------------|---------------|---------|---------|---------|-----|
| 22" | 72" | 2L72-CND | 25L72-CND | \$2,873 | \$3,026 | \$3,155 | 348 |
| 22" | 60" | 2L60-CPD | 25L60-CPD | \$2,659 | \$2,814 | \$2,943 | 332 |

LEFT - Box/box/file - Pedestal
RIGHT - File/file - Pedestal
CENTER - Two Doors
SHIPS FULLY ASSEMBLED
 *****2CL - LOCKING_ FOR ENTIRE UNIT*****
 ADD \$334 LIST

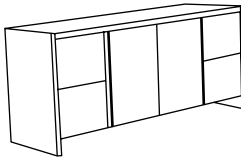

| D | W | Recessed Front # | Flush Front # | Zone 0 | Zone 1 | Zone 2 | WT |
|-----|-----|------------------|---------------|---------|---------|---------|-----|
| 22" | 72" | 2L72-DND | 25L72-DND | \$2,873 | \$3,026 | \$3,155 | 348 |
| 22" | 60" | 2L60-DPD | 25L60-DPD | \$2,659 | \$2,814 | \$2,943 | 332 |

LEFT - File/file - Pedestal
RIGHT - File/file - Pedestal
CENTER - Two Doors
SHIPS FULLY ASSEMBLED
 *****2CL - LOCKING_ FOR ENTIRE UNIT*****
 ADD \$334 LIST

Classic 11



Classic Collection



Edge

SERIES 200 - The Classic Collection Executive Credenzas

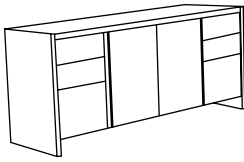

| D | W | Recessed Front # | Flush Front # | Zone 0 | Zone 1 | Zone 2 | WT |
|-----|-----|------------------|---------------|---------|---------|---------|-----|
| 22" | 72" | 2L72-CNC | 25L72-CNC | \$2,873 | \$3,026 | \$3,155 | 348 |
| 22" | 60" | 2L60-CPC | 25L60-CPC | \$2,659 | \$2,814 | \$2,943 | 332 |

LEFT - Box/file/file - Pedestal
RIGHT - Box/file/file - Pedestal
CENTER - Two Doors
SHIPS FULLY ASSEMBLED

*****2CL - LOCKING_ FOR ENTIRE UNIT*****
ADD \$334 LIST

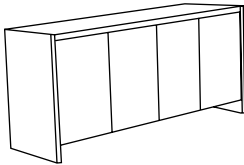

| D | W | Recessed Front # | Flush Front # | Zone 0 | Zone 1 | Zone 2 | WT |
|-----|-----|------------------|---------------|---------|---------|---------|-----|
| 22" | 72" | 2L72-NN | 25L72-NN | \$2,187 | \$2,340 | \$2,470 | 348 |
| 22" | 60" | 2L60-QQ | 25L60-QQ | \$2,062 | \$2,229 | \$2,358 | 332 |

Four Doors
SHIPS FULLY ASSEMBLED

*****2CL - LOCKING_ FOR ENTIRE UNIT*****
ADD \$334 LIST

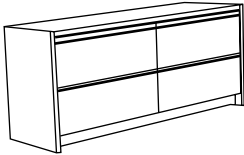

| D | W | Recessed Front # | Flush Front # | Zone 0 | Zone 1 | Zone 2 | WT |
|-----|-----|------------------|---------------|---------|---------|---------|-----|
| 22" | 72" | 2L72-GG | 25L72-GG | \$2,984 | \$3,138 | \$3,267 | 330 |

Four Drawer Lateral
SHIPS FULLY ASSEMBLED

*****2CL - LOCKING_ FOR ENTIRE UNIT*****
ADD \$334 LIST

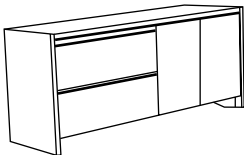

| D | W | Recessed Front # | Flush Front # | Zone 0 | Zone 1 | Zone 2 | WT |
|-----|-----|------------------|---------------|---------|---------|---------|-----|
| 22" | 60" | 2L60-GP | 25L60-GP | \$2,547 | \$2,702 | \$2,831 | 282 |

LEFT - Two Drawer Lateral File
RIGHT - Two Doors
SHIPS FULLY ASSEMBLED

*****2CL - LOCKING_ FOR ENTIRE UNIT*****
ADD \$334 LIST

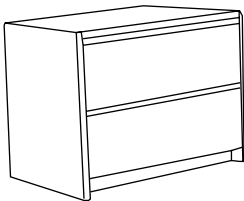

| D | W | Recessed Front # | Flush Front # | Zone 0 | Zone 1 | Zone 2 | WT |
|-----|-------|------------------|---------------|---------|---------|---------|-----|
| 22" | 37.5" | 2L36-GL | 25L36-GL | \$1,551 | \$1,706 | \$1,834 | 210 |

NOTE: Locks are standard
SHIPS FULLY ASSEMBLED

Classic 12



Classic Collection



SERIES 200 - The Classic Collection Table Desks

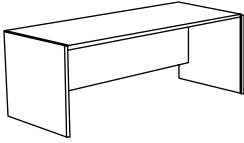

| D | W | Recessed Front # | Flush Front # | Recessed to Floor# | Zone 0 | Zone 1 | Zone 2 | WT |
|-----|-----|------------------|---------------|--------------------|---------|---------|---------|-----|
| 30" | 72" | 2T20 | 25T20 | 21T20 | \$1,337 | \$1,486 | \$1,611 | 318 |
| 30" | 66" | 2T60 | 25T60 | 21T60 | \$1,277 | \$1,426 | \$1,551 | 288 |
| 30" | 60" | 2T00 | 25T00 | 21T60 | \$1,216 | \$1,365 | \$1,490 | 258 |
| 30" | 48" | 2T80 | 25T80 | 21T80 | \$1,058 | \$1,209 | \$1,333 | 216 |
| 30" | 42" | 2T02 | 25T02 | 21T02 | \$914 | \$1,063 | \$1,188 | 210 |
| 24" | 72" | 2T24 | 25T24 | 21T24 | \$1,095 | \$1,244 | \$1,369 | 214 |
| 24" | 66" | 2T64 | 25T64 | 21T64 | \$1,047 | \$1,197 | \$1,321 | 195 |
| 24" | 60" | 2T04 | 25T04 | 21T04 | \$1,022 | \$1,172 | \$1,297 | 192 |
| 24" | 48" | 2T84 | 25T84 | 21T84 | \$877 | \$1,027 | \$1,151 | 168 |
| 24" | 42" | 2T42 | 25T42 | 21T42 | \$828 | \$978 | \$1,103 | 155 |
| 24" | 36" | 2T46 | 25T46 | 21T46 | \$816 | \$967 | \$1,091 | 162 |

All Table Desk are 29"H

SHIPS FULLY ASSEMBLED

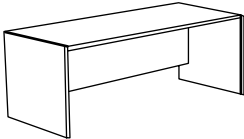

| D | W | Recessed to Floor# | Zone 0 | Zone 1 | Zone 2 | WT |
|-----|-----|--------------------|---------|---------|---------|-----|
| 24" | 72" | 2T6472 | \$1,095 | \$1,244 | \$1,369 | 204 |
| 24" | 60" | 2T6460 | \$998 | \$1,148 | \$1,272 | 186 |
| 24" | 48" | 2T6448 | \$889 | \$1,039 | \$1,163 | 168 |
| 24" | 36" | 2T6436 | \$792 | \$942 | \$1,067 | 142 |
| 24" | 30" | 2T6430 | \$768 | \$918 | \$1,042 | 132 |
| 24" | 24" | 2T6424 | \$707 | \$858 | \$982 | 108 |
| 30" | 72" | 2T6072 | \$1,337 | \$1,486 | \$1,611 | 214 |
| 30" | 60" | 2T6060 | \$1,191 | \$1,341 | \$1,466 | 192 |
| 30" | 48" | 2T6048 | \$1,034 | \$1,184 | \$1,309 | 168 |

All Table Desk are 26"H

SHIPS FULLY ASSEMBLED

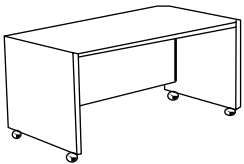

| D | W | Recessed to Floor# | Zone 0 | Zone 1 | Zone 2 | WT |
|-----|-----|--------------------|--------|---------|---------|-----|
| 24" | 36" | 2TC436 | \$877 | \$1,027 | \$1,103 | 142 |
| 24" | 60" | 2TC430 | \$840 | \$990 | \$1,116 | 132 |
| 24" | 48" | 2TC424 | \$828 | \$978 | \$1,103 | 108 |

All table are 29"H with casters

SHIPS FULLY ASSEMBLED

SERIES 200 - The Classic Collection Overstorage Components / Task Lights

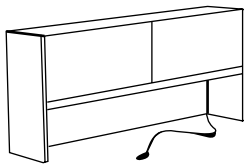

| H | W | Model# | Zone 0 | Zone 1 | Zone 2 | WT |
|-----|-----|------------------|---------|---------|---------|-----|
| 36" | 78" | 2F678 | \$2,449 | \$2,600 | \$2,724 | 222 |
| 36" | 72" | 2F672 | \$2,280 | \$2,430 | \$2,554 | 216 |
| 36" | 66" | 2F666 | \$2,244 | \$2,393 | \$2,519 | 202 |
| 36" | 60" | 2F660 | \$2,196 | \$2,346 | \$2,470 | 182 |
| 36" | 48" | 2F648 (one door) | \$1,905 | \$2,055 | \$2,179 | 166 |
| 36" | 36" | 2F636 (one door) | \$1,845 | \$1,995 | \$2,119 | 149 |

Flipper Door - 15"D

NOTE: Task Light included all units

10' cord standard

We recommend a cable cut-out on base unit

SHIPS FULLY ASSEMBLED

SECTION VIEW

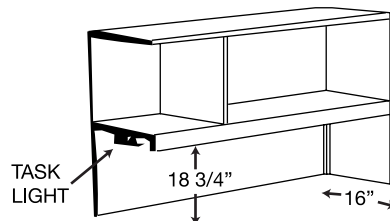

Classic 13



Classic Collection

Edge

SERIES 200 - The Classic Collection Overstorage Components / Task Lights

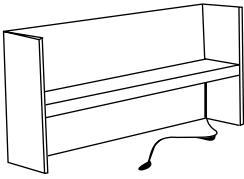

| H | W | Model# | Zone 0 | Zone 1 | Zone 2 | WT |
|-----|-----|--------|---------|---------|---------|-----|
| 36" | 78" | 2S678 | \$1,808 | \$1,958 | \$2,083 | 192 |
| 36" | 72" | 2S672 | \$1,760 | \$1,909 | \$2,035 | 186 |
| 36" | 66" | 2S666 | \$1,724 | \$1,874 | \$1,998 | 176 |
| 36" | 60" | 2S660 | \$1,663 | \$1,813 | \$1,938 | 168 |
| 36" | 48" | 2S648 | \$1,458 | \$1,607 | \$1,732 | 144 |
| 36" | 36" | 2F636 | \$1,385 | \$1,535 | \$1,660 | 118 |

Open Shelf - 15"D

SHIPS FULLY ASSEMBLED

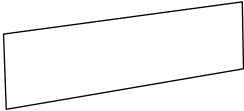

| H | W | Model# | Zone 0 | Zone 1 | Zone 2 | WT |
|-----|-----|--------|--------|--------|--------|----|
| 18" | 78" | 2P678 | \$381 | \$446 | \$511 | 19 |
| 18" | 72" | 2P672 | \$369 | \$434 | \$498 | 18 |
| 18" | 66" | 2P666 | \$356 | \$422 | \$486 | 17 |
| 18" | 60" | 2P660 | \$333 | \$397 | \$462 | 16 |
| 18" | 48" | 2P648 | \$309 | \$374 | \$437 | 13 |
| 18" | 36" | 2P636 | \$235 | \$301 | \$365 | 10 |

Tackboard Panels

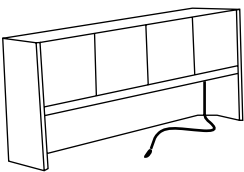

| H | W | Model# | Zone 0 | Zone 1 | Zone 2 | WT |
|-----|-----|---------|---------|---------|---------|-----|
| 42" | 72" | 2D22-CB | \$2,824 | \$2,974 | \$3,099 | 302 |
| 42" | 60" | 2D02-CB | \$2,582 | \$2,732 | \$2,857 | 254 |

Hinged Door 15" D

SHIPS FULLY ASSEMBLED

NOTE: Hinged door overstorage clearance is 21"

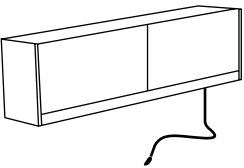

| H | W | Model# | Zone 0 | Zone 1 | Zone 2 | WT |
|-----|-----|------------------|---------|---------|---------|-----|
| 17" | 72" | 2FH72 | \$1,893 | \$2,043 | \$2,168 | 160 |
| 17" | 66" | 2FH66 | \$1,833 | \$1,983 | \$2,107 | 153 |
| 17" | 60" | 2FH60 | \$1,772 | \$1,920 | \$2,047 | 145 |
| 17" | 54" | 2FH54 | \$1,700 | \$1,849 | \$1,974 | 138 |
| 17" | 48" | 2FH48 (one door) | \$1,398 | \$1,547 | \$1,672 | 128 |
| 17" | 42" | 2FH42 (one door) | \$1,337 | \$1,486 | \$1,611 | 121 |
| 17" | 36" | 2FH36 (one door) | \$1,264 | \$1,414 | \$1,539 | 114 |
| 17" | 30" | 2FH30 (one door) | \$1,203 | \$1,353 | \$1,479 | 107 |

Wall Hung Flipper Door 15"D

SHIPS FULLY ASSEMBLED



| H | W | Model# | Zone 0 | Zone 1 | Zone 2 | WT |
|-----|-----|--------|---------|---------|---------|-----|
| 17" | 72" | 2SH72 | \$1,409 | \$1,560 | \$1,684 | 112 |
| 17" | 66" | 2SH66 | \$1,385 | \$1,535 | \$1,668 | 109 |
| 17" | 60" | 2SH60 | \$1,337 | \$1,486 | \$1,644 | 105 |
| 17" | 54" | 2SH54 | \$1,277 | \$1,426 | \$1,551 | 102 |
| 17" | 48" | 2SH48 | \$1,191 | \$1,341 | \$1,466 | 96 |
| 17" | 42" | 2SH42 | \$1,082 | \$1,232 | \$1,358 | 93 |
| 17" | 36" | 2SH36 | \$914 | \$1,063 | \$1,188 | 90 |
| 17" | 30" | 2SH30 | \$780 | \$930 | \$1,055 | 87 |

NOTE: To Add Top - \$301 additional

SHIPS FULLY ASSEMBLED

WALL HUNG OPEN SHELF 15" D

Classic 14



Classic Collection

Edge

SERIES 200 - The Classic Collection Run-Off Tables

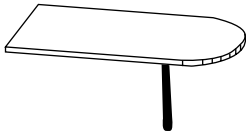

| Dimensions | Model# | Zone 0 | Zone 1 | Zone 2 | WT |
|------------|--------|--------|---------|---------|-----|
| 30" x 66" | RT3066 | \$961 | \$1,063 | \$1,163 | 114 |
| 30" x 60" | RT3060 | \$901 | \$1,015 | \$1,116 | 96 |
| 30" x 54" | RT3054 | \$877 | \$978 | \$1,079 | 77 |

SHIPS KD

Freestanding Run-Off Tables

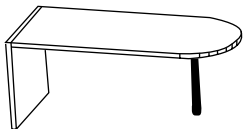

| Dimensions | Model# | Zone 0 | Zone 1 | Zone 2 | WT |
|------------|---------|---------|---------|---------|-----|
| 30" x 60" | 2RT3060 | \$1,167 | \$1,281 | \$1,381 | 128 |
| 30" x 66" | 2RT3066 | \$1,252 | \$1,365 | \$1,490 | 146 |
| 30" x 72" | 2RT3072 | \$1,324 | \$1,439 | \$1,551 | 164 |

SHIPS KD

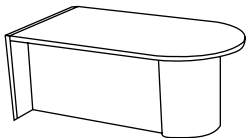

| Dimensions | Model# | Zone 0 | Zone 1 | Zone 2 | WT |
|------------|----------|---------|---------|---------|-----|
| 30" x 60" | 2MRT3060 | \$2,268 | \$2,393 | \$2,542 | 204 |
| 30" x 66" | 2MRT3066 | \$2,413 | \$2,539 | \$2,688 | 229 |
| 30" x 72" | 2MRT3072 | \$2,547 | \$2,672 | \$2,796 | 252 |

Half Cylinder w/ Modesty Panel
SHIPS FULLY ASSEMBLED

The Classic Collection "P" Tables

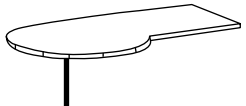

| Dimensions | Model# | Zone 0 | Zone 1 | Zone 2 | WT |
|-----------------|--------|---------|---------|---------|-----|
| 30" x 66" x 42" | PT3066 | \$1,228 | \$1,450 | \$1,466 | 129 |
| 30" x 72" x 42" | PT3072 | \$1,470 | \$1,595 | \$1,707 | 138 |
| 36" x 66" x 48" | PT3666 | \$1,615 | \$1,741 | \$1,853 | 142 |
| 36" x 72" x 48" | PT3672 | \$1,724 | \$1,849 | \$1,962 | 151 |

NOTE: Mounting holes are predrilled
SHIPS KD

SERIES 200 - The Classic Collection "P" Tables - Freestanding "P" Tables

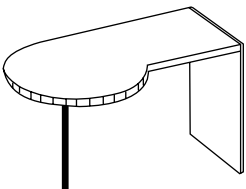

| Dimensions | Model# | Zone 0 | Zone 1 | Zone 2 | WT |
|-----------------|---------|---------|---------|---------|-----|
| 30" x 66" x 42" | 2PT3066 | \$1,409 | \$1,523 | \$1,647 | 160 |
| 30" x 72" x 42" | 2PT3072 | \$1,591 | \$1,704 | \$1,828 | 169 |
| 36" x 66" x 48" | 2PT3666 | \$1,687 | \$1,812 | \$1,938 | 173 |
| 36" x 72" x 48" | 2PT3672 | \$1,821 | \$1,934 | \$2,058 | 182 |

NOTE: Mounting holes are predrilled
SHIPS KD

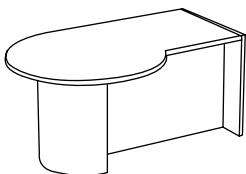

| Dimensions | Model# | Zone 0 | Zone 1 | Zone 2 | WT |
|-----------------|----------|---------|---------|---------|-----|
| 30" x 66" x 42" | 2MPT3066 | \$2,522 | \$2,635 | \$2,749 | 229 |
| 30" x 72" x 42" | 2MPT3072 | \$2,655 | \$2,769 | \$2,881 | 252 |
| 36" x 66" x 48" | 2MPT3666 | \$2,789 | \$2,902 | \$3,014 | 254 |
| 36" x 72" x 48" | 2MPT3672 | \$2,921 | \$3,035 | \$3,147 | 277 |

NOTE: Mounting holes are predrilled
Half cylinder w/Modesty Panel
SHIPS FULLY ASSEMBLED

Classic 15



Classic Collection



Edge

SERIES 5000 - Component Work Areas

Tops 1 1/8" particle board, 45 lb. density, high pressure laminate on top and edges plus backing on bottom
Intermediate sizes: Specify length using next higher size price.

Order by: 5WT Width X Length

Shipping Weight = 5lb X Sq Ft.

The Component Series allows you to shape your own work space.

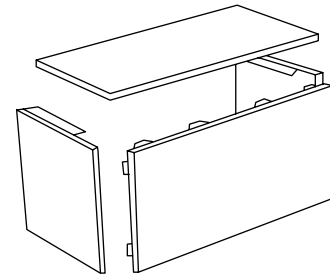
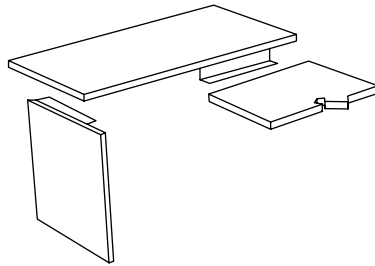
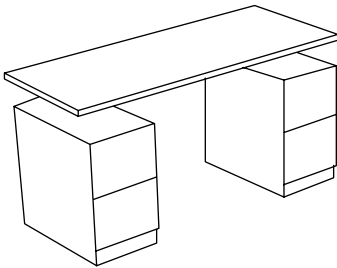

Component Work Tops

| H | W | Model# | Zone 0 | Zone 1 | Zone 2 |
|-----|------|----------|---------|---------|---------|
| 24" | 42" | 5WT2442 | \$248 | \$313 | \$365 |
| 24" | 48" | 5WT2448 | \$284 | \$349 | \$401 |
| 24" | 54" | 5WT2454 | \$333 | \$397 | \$450 |
| 24" | 60" | 5WT2460 | \$345 | \$410 | \$462 |
| 24" | 66" | 5WT2466 | \$417 | \$483 | \$535 |
| 24" | 72" | 5WT2472 | \$454 | \$446 | \$498 |
| 24" | 84" | 5WT2484 | \$501 | \$567 | \$619 |
| 24" | 96" | 5WT2496 | \$575 | \$639 | \$692 |
| 24" | 108" | 5WT24108 | \$659 | \$725 | \$777 |
| 24" | 120" | 5WT24120 | \$744 | \$809 | \$861 |
| 30" | 30" | 5WT3030 | \$175 | \$241 | \$293 |
| 30" | 36" | 5WT3036 | \$235 | \$301 | \$353 |
| 30" | 42" | 5WT3042 | \$284 | \$350 | \$402 |
| 30" | 48" | 5WT3048 | \$333 | \$397 | \$450 |
| 30" | 54" | 5WT3054 | \$381 | \$446 | \$498 |
| 30" | 60" | 5WT3060 | \$393 | \$458 | \$511 |
| 30" | 66" | 5WT3066 | \$442 | \$507 | \$558 |
| 30" | 72" | 5WT3072 | \$477 | \$543 | \$595 |
| 30" | 84" | 5WT3084 | \$563 | \$627 | \$679 |
| 30" | 96" | 5WT3096 | \$659 | \$725 | \$777 |
| 30" | 108" | 5WT30108 | \$744 | \$809 | \$861 |
| 30" | 120" | 5WT30120 | \$828 | \$894 | \$946 |
| 36" | 24" | 5WT3624 | \$200 | \$265 | \$316 |
| 36" | 30" | 5WT3630 | \$235 | \$301 | \$353 |
| 36" | 36" | 5WT3636 | \$284 | \$350 | \$402 |
| 36" | 42" | 5WT3642 | \$333 | \$397 | \$450 |
| 36" | 48" | 5WT3648 | \$393 | \$458 | \$511 |
| 36" | 54" | 5WT3654 | \$454 | \$518 | \$571 |
| 36" | 60" | 5WT3660 | \$477 | \$543 | \$595 |
| 36" | 66" | 5WT3666 | \$538 | \$604 | \$656 |
| 36" | 72" | 5WT3672 | \$586 | \$652 | \$704 |
| 36" | 84" | 5WT3684 | \$696 | \$760 | \$813 |
| 36" | 96" | 5WT3696 | \$805 | \$869 | \$921 |
| 36" | 108" | 5WT36108 | \$914 | \$978 | \$1,030 |
| 36" | 120" | 5WT36120 | \$1,022 | \$1,088 | \$1,139 |

Classic 16



SERIES 5000 - Component Modesty Panels

Modesty Panels are 1 1/4" thick particle board, 45lb. Density, high pressure laminate on both sides.

To determine price on intermediate sizes, use price shown for the next larger length.

Modesty panels are supplied with angle brackets for mounting to legs and tops.

Modesty panels is designed to go underneath top and between legs. Three edges of panel are unfinished.

Order by: 5MP Width X Length

Shipping Weight = 5lb X Sq Ft.

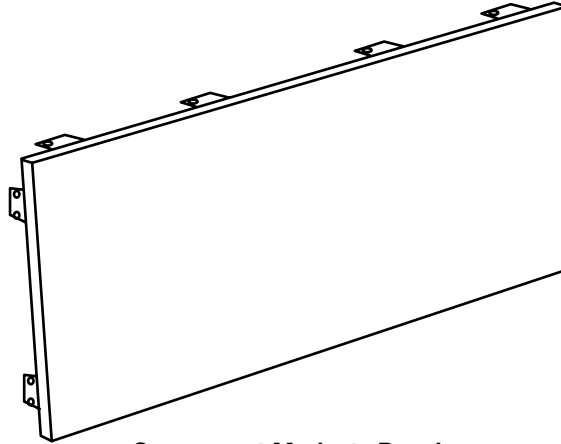

Component Modesty Panels

| W | L | Model# | Zone 0 | Zone 1 | Zone 2 |
|------|-----|----------|--------|--------|--------|
| 24" | 25" | 5MP2425 | \$114 | \$180 | \$232 |
| 30" | 25" | 5MP3025 | \$163 | \$229 | \$281 |
| 36" | 25" | 5MP3625 | \$212 | \$276 | \$329 |
| 42" | 25" | 5MP4225 | \$260 | \$325 | \$377 |
| 48" | 25" | 5MP4825 | \$296 | \$362 | \$414 |
| 54" | 25" | 5MP5425 | \$345 | \$410 | \$462 |
| 60" | 25" | 5MP6025 | \$369 | \$434 | \$486 |
| 66" | 25" | 5MP6625 | \$405 | \$471 | \$523 |
| 72" | 25" | 5MP7225 | \$454 | \$518 | \$571 |
| 84" | 25" | 5MP8425 | \$526 | \$592 | \$644 |
| 96" | 25" | 5MP9625 | \$744 | \$809 | \$861 |
| 108" | 25" | 5MP10825 | \$756 | \$821 | \$874 |
| 120" | 25" | 5MP12025 | \$780 | \$846 | \$897 |
| 24" | 28" | 5MP2428 | \$163 | \$229 | \$281 |
| 30" | 28" | 5MP3028 | \$188 | \$253 | \$305 |
| 36" | 28" | 5MP3628 | \$248 | \$313 | \$365 |
| 42" | 28" | 5MP4228 | \$296 | \$362 | \$414 |
| 48" | 28" | 5MP4828 | \$356 | \$422 | \$474 |
| 54" | 28" | 5MP5428 | \$405 | \$471 | \$523 |
| 60" | 28" | 5MP6028 | \$417 | \$483 | \$535 |
| 66" | 28" | 5MP6628 | \$430 | \$495 | \$546 |
| 72" | 28" | 5MP7228 | \$477 | \$543 | \$595 |
| 84" | 28" | 5MP8428 | \$575 | \$639 | \$692 |
| 96" | 28" | 5MP9628 | \$719 | \$725 | \$753 |
| 108" | 28" | 5MP10828 | \$552 | \$821 | \$874 |
| 120" | 28" | 5MP12028 | \$853 | \$918 | \$970 |

NOTE: Must supply drawing for size adjustment on modesty



Classic Collection



Edge

SERIES 5000 - Component Work Area

Panel Supports

1 1/8" particle board, 45lb. density, high pressure laminate on all exposed surfaces.

Supplied with mounting hardware and leveling glides

Order by: 5PS Width X Length

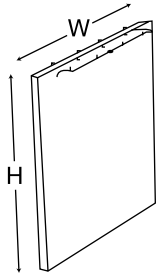

| W | H | Model # | Zone 0 | Zone 1 | Zone 2 | WT |
|-----|-----|---------|--------|--------|--------|----|
| 22" | 25" | 5PS2225 | \$175 | \$216 | \$256 | 19 |
| 24" | 25" | 5PS2425 | \$229 | \$272 | \$353 | 26 |
| 30" | 25" | 5PS3025 | \$212 | \$253 | \$293 | 36 |
| 36" | 25" | 5PS3625 | \$272 | \$313 | \$353 | 46 |
| 12" | 25" | 5PS1225 | \$163 | \$204 | \$244 | 11 |
| 15" | 25" | 5PS1525 | \$175 | \$216 | \$256 | 14 |
| 22" | 28" | 5PS2228 | \$188 | \$229 | \$269 | 19 |
| 24" | 28" | 5PS2428 | \$284 | \$241 | \$365 | 26 |
| 30" | 28" | 5PS3028 | \$224 | \$265 | \$305 | 36 |
| 36" | 28" | 5PS3628 | \$284 | \$325 | \$365 | 46 |
| 12" | 28" | 5PS1228 | \$175 | \$216 | \$256 | 11 |
| 15" | 28" | 5PS1528 | \$188 | \$229 | \$269 | 14 |

Corner Top

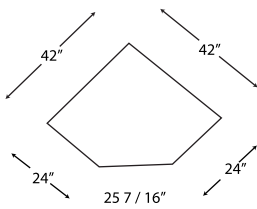

| Model # | Zone 0 | Zone 1 | Zone 2 | WT |
|---------|--------|--------|--------|----|
| 5CT | \$460 | \$507 | \$546 | 65 |

Corner Leg Support

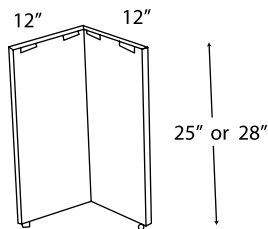

| H | Model # | Zone 0 | Zone 1 | Zone 2 | WT |
|-----|---------|--------|--------|--------|----|
| 25" | 5CLS25 | \$417 | \$458 | \$498 | 30 |
| 28" | 5CLS28 | \$430 | \$471 | \$511 | 30 |

NOTE: Corner Leg support is shipped in two pieces & is assembled with mod-eza clips.

Freestanding Corner

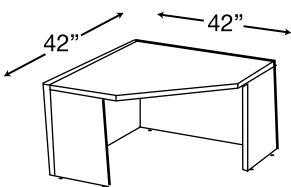

| H | Model # | Zone 0 | Zone 1 | Zone 2 | WT |
|-----|---------|---------|---------|---------|-----|
| 26" | 5CTBP26 | \$1,156 | \$1,197 | \$1,237 | 190 |
| 29" | 5CTBP29 | \$1,156 | \$1,197 | \$1,237 | 190 |

SHIPS FULLY ASSEMBLED

Classic 18



SERIES 5000 - Component Work Area Mounting Hardware

Flat Plates



| Model# | Length (in.) | Unit Price |
|--------|--------------|------------|
| 5MH-2 | 13 | \$32 |
| 5MH-5 | 8 | \$27 |

"L" Angles

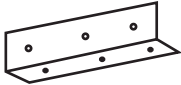

| Model# | Length (in.) | Unit Price |
|--------|--------------|------------|
| 5MH-3 | 20 | \$43 |

Spacers

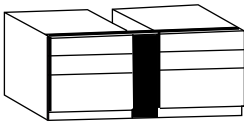

| Dimensions | Model# | Unit Price |
|--------------------|--------|------------|
| 1 1/4 x 24"H x 5"D | SPA-24 | \$108 |
| 1 1/4"x27 3/4Hx5"D | SPA-27 | \$108 |

Spacers available when ganging
900 Series Freestanding Pedestals



Classic Collection



Edge

SERIES 1100 - Freestanding Bookcase

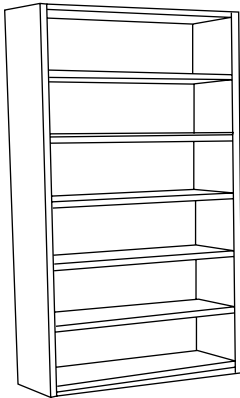

| Shelves | H | D | 30"W Model | Zone 0 | Zone 1 | Zone 2 | WT |
|---------|-----|-----|------------|---------|---------|---------|-----|
| 7 | 84" | 12" | 11B084-F | \$1,833 | \$1,874 | \$1,914 | 215 |
| 6 | 78" | 12" | 11B078-F | \$1,724 | \$1,765 | \$1,805 | 201 |
| 5 | 72" | 12" | 11B072-F | \$1,615 | \$1,656 | \$1,696 | 187 |
| 4 | 60" | 12" | 11B060-F | \$1,458 | \$1,499 | \$1,539 | 166 |
| 3 | 48" | 12" | 11B048-F | \$1,191 | \$1,232 | \$1,272 | 145 |
| 2 | 41" | 12" | 11B041-F | \$1,070 | \$1,111 | \$1,151 | 131 |
| 2 | 36" | 12" | 11B036-F | \$974 | \$1,015 | \$1,055 | 127 |
| 1 | 28" | 12" | 11B028-F | \$902 | \$942 | \$982 | 117 |
| 7 | 84" | 18" | 11B8084-F | \$2,268 | \$2,309 | \$2,349 | 294 |
| 6 | 78" | 18" | 11B8078-F | \$2,110 | \$2,151 | \$2,191 | 274 |
| 5 | 72" | 18" | 11B8072-F | \$1,966 | \$2,007 | \$2,047 | 255 |
| 4 | 60" | 18" | 11B8060-F | \$1,736 | \$1,777 | \$1,817 | 225 |
| 3 | 48" | 18" | 11B8048-F | \$1,433 | \$1,474 | \$1,514 | 196 |
| 2 | 41" | 18" | 11B8041-F | \$1,275 | \$1,318 | \$1,358 | 175 |
| 2 | 36" | 18" | 11B8036-F | \$1,131 | \$1,172 | \$1,212 | 147 |
| 1 | 28" | 18" | 11B8028-F | \$1,047 | \$1,088 | \$1,128 | 144 |

30" Wide Bookcases

**NOTE: ALL UNITS ARE FINISHED ON ALL SIDES
SHIPS FULLY ASSEMBLED**

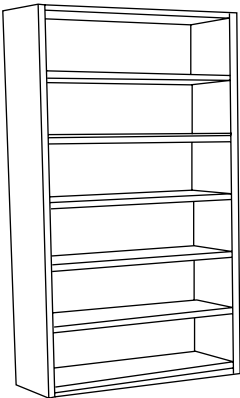

| Shelves | H | D | 36"W Model | Zone 0 | Zone 1 | Zone 2 | WT |
|---------|-----|-----|------------|---------|---------|---------|-----|
| 7 | 84" | 12" | 11B84-F | \$2,014 | \$2,055 | \$2,095 | 215 |
| 6 | 78" | 12" | 11B78-F | \$1,893 | \$1,934 | \$1,974 | 201 |
| 5 | 72" | 12" | 11B72-F | \$1,760 | \$1,801 | \$1,841 | 187 |
| 4 | 60" | 12" | 11B60-F | \$1,579 | \$1,620 | \$1,663 | 166 |
| 3 | 48" | 12" | 11B48-F | \$1,288 | \$1,329 | \$1,369 | 145 |
| 2 | 41" | 12" | 11B41-F | \$1,167 | \$1,209 | \$1,248 | 131 |
| 2 | 36" | 12" | 11B36-F | \$1,156 | \$1,197 | \$1,237 | 127 |
| 1 | 28" | 12" | 11B28-F | \$961 | \$1,002 | \$1,042 | 117 |
| 7 | 84" | 18" | 11B8684-F | \$2,498 | \$2,539 | \$2,579 | 294 |
| 6 | 78" | 18" | 11B8678-F | \$2,328 | \$2,370 | \$2,409 | 274 |
| 5 | 72" | 18" | 11B8672-F | \$2,171 | \$2,200 | \$2,216 | 255 |
| 4 | 60" | 18" | 11B8660-F | \$1,905 | \$1,946 | \$1,986 | 225 |
| 3 | 48" | 18" | 11B8648-F | \$1,566 | \$1,607 | \$1,647 | 196 |
| 2 | 41" | 18" | 11B8641-F | \$1,385 | \$1,426 | \$1,466 | 175 |
| 2 | 36" | 18" | 11B8636-F | \$1,216 | \$1,257 | \$1,297 | 147 |
| 1 | 28" | 18" | 11B8628-F | \$1,119 | \$1,160 | \$1,200 | 144 |

36" Wide Bookcases

**NOTE: ALL UNITS ARE FINISHED ON ALL SIDES
SHIPS FULLY ASSEMBLED**

Classic 20



Classic Collection



Edge

SERIES 1100 - Storage Cabinets and Wardrobes

| Finished Outside Back | Shelves | H | D | 36"W Model | Zone 0 | Zone 1 | Zone 2 | WT |
|-----------------------|---------|-----|-----|------------|---------|---------|---------|-----|
| | 5 | 72" | 19" | 11C72-F | \$2,292 | \$2,393 | \$2,494 | 344 |
| | 4 | 60" | 19" | 11C60-F | \$1,893 | \$1,995 | \$2,095 | 268 |
| | 3 | 48" | 19" | 11C48-F | \$1,615 | \$1,788 | \$1,817 | 250 |
| | 2 | 41" | 19" | 11C41-F | \$1,603 | \$1,704 | \$1,805 | 248 |
| | 2 | 36" | 19" | 11C36-F | \$1,398 | \$1,499 | \$1,599 | 170 |
| | 1 | 28" | 19" | 11C28-F | \$1,275 | \$1,378 | \$1,479 | 130 |

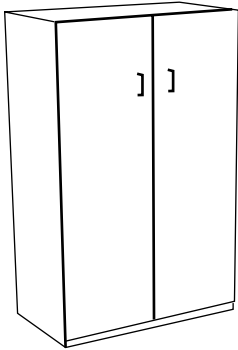

Storage Cabinets - with adjustable shelves

NOTE: All units are finished on all sides; includes adjustable levelers.

Inside measurements of storage cabinets are standard:

34 3/8"W x 17 3/4"D x 25"H

34 3/8"W x 17 3/4"D x 33"H

34 3/8"W x 17 3/4"D x 38"H

34 3/8"W x 17 3/4"D x 45"H

34 3/8"W x 17 3/4"D x 57"H

SHIPS FULLY ASSEMBLED

LOCK ON STORAGE CABINET \$151 LIST

| W | D | H | Model# | Zone 0 | Zone 1 | Zone 2 | WT |
|-----|-----|-----|---------|---------|---------|---------|-----|
| 36" | 24" | 72" | 11CW-72 | \$2,800 | \$2,902 | \$3,002 | 322 |

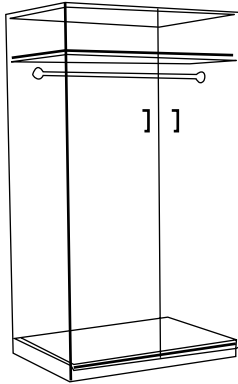

Two Doors w/Hat Shelf & Coat Pole

SHIPS FULLY ASSEMBLED

LOCK ON STORAGE CABINET \$151 LIST

| W | D | H | Model# | Zone 0 | Zone 1 | Zone 2 | WT |
|-----|-----|-----|----------|---------|---------|---------|-----|
| 36" | 24" | 72" | 11CWC-72 | \$3,103 | \$3,204 | \$3,305 | 322 |

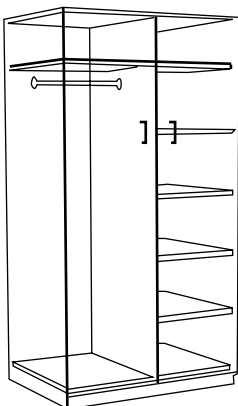

Two Doors w/Hat Shelf & Coat Pole on one side and Shelves on other side.

SHIPS FULLY ASSEMBLED

LOCK ON STORAGE CABINET \$151 LIST

Classic 21



Classic Collection



Edge

SERIES 1100 - Bookcases/Storage and Storage/Lateral Combinations

| Bookcase/Storage | W | D | H | Model# | Zone 0 | Zone 1 | Zone 2 | WT |
|------------------|-----|-----|-----|----------|---------|---------|---------|-----|
| | 36" | 22" | 76" | 9K22LLBC | \$2,933 | \$3,035 | \$3,415 | 350 |

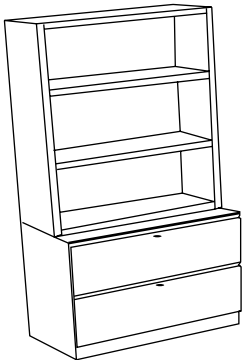

NOTE: Locks are standard
SHIPS FULLY ASSEMBLED

| | W | D | H | Model# | Zone 0 | Zone 1 | Zone 2 | WT |
|--|-----|-----|-----|-----------|---------|---------|---------|-----|
| | 36" | 22" | 76" | 9K22DDSBC | \$2,678 | \$2,781 | \$3,161 | 322 |

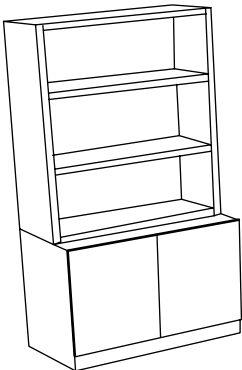

SHIPS FULLY ASSEMBLED
LOCK ON STORAGE CABINET \$151 LIST

| | W | D | H | Model# | Zone 0 | Zone 1 | Zone 2 | WT |
|--|-----|-----|-----|----------|---------|---------|---------|-----|
| | 36" | 22" | 72" | 9K22LLSC | \$3,175 | \$3,277 | \$3,377 | 385 |

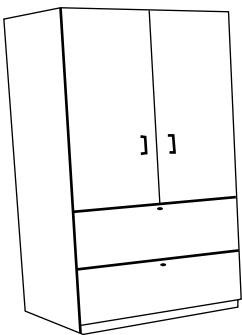

SHIPS FULLY ASSEMBLED
LOCK ON STORAGE CABINET \$151 LIST

Classic 22



Classic Collection



SERIES 900 - Free Standing Pedestals

Base Pedestal

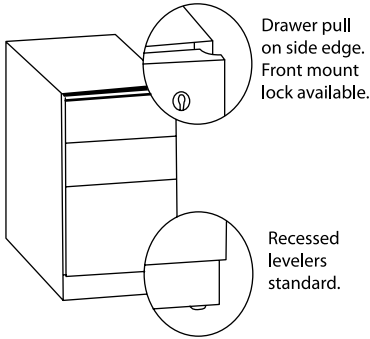

Drawer pull on side edge. Front mount lock available.

Recessed levelers standard.

Mobile Pedestal

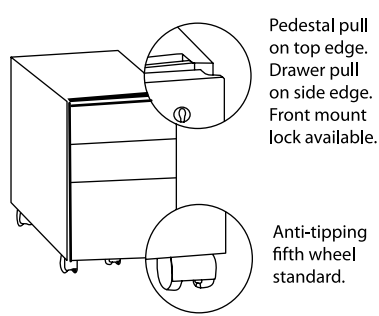

Pedestal pull on top edge. Drawer pull on side edge. Front mount lock available.

Anti-tipping fifth wheel standard.

| D | W | 28"H / Model# | Zone 0 | Zone 1 | Zone 2 | WT |
|-----|-----|---------------|---------|---------|---------|-----|
| 18" | 16" | 9K18-BBF | \$817 | \$871 | \$924 | 96 |
| 22" | 16" | 9K22-BBF | \$916 | \$970 | \$1,025 | 108 |
| 28" | 16" | 9K28-BBF | \$1,003 | \$1,058 | \$1,111 | 126 |

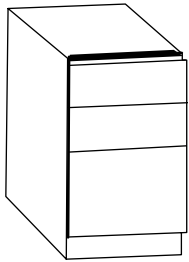

Base Pedestal

Box/box/file -BBF

SHIPS FULLY ASSEMBLED

NOTE: FOR LOCK ADD /L TO MODEL # AND ADD \$111 TO LIST.

| D | W | 27"H / Model# | Zone 0 | Zone 1 | Zone 2 | WT |
|-----|-----|---------------|---------|---------|---------|-----|
| 18" | 16" | 9C18-BBF | \$817 | \$871 | \$924 | 96 |
| 22" | 16" | 9C22-BBF | \$916 | \$970 | \$1,025 | 108 |
| 28" | 16" | 9C28-BBF | \$1,003 | \$1,058 | \$1,111 | 126 |

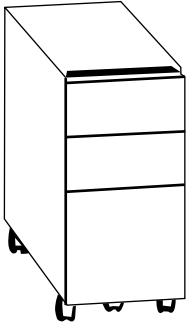

Mobile Pedestal

Box/box/file -BBF

SHIPS FULLY ASSEMBLED

NOTE: FOR LOCK ADD /L TO MODEL # AND ADD \$111 TO LIST.

| D | W | 28"H / Model# | Zone 0 | Zone 1 | Zone 2 | WT |
|-----|-----|---------------|---------|---------|---------|-----|
| 18" | 16" | 9K18-FF | \$817 | \$871 | \$924 | 96 |
| 22" | 16" | 9K22-FF | \$916 | \$970 | \$1,025 | 108 |
| 28" | 16" | 9K28-FF | \$1,003 | \$1,058 | \$1,111 | 126 |

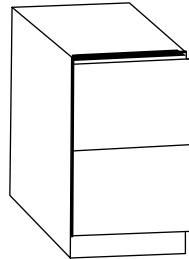

Base Pedestal

File/file -FF

SHIPS FULLY ASSEMBLED

NOTE: FOR LOCK ADD /L TO MODEL # AND ADD \$111 TO LIST.

| D | W | 27"H / Model# | Zone 0 | Zone 1 | Zone 2 | WT |
|-----|-----|---------------|---------|---------|---------|-----|
| 18" | 16" | 9C18-FF | \$817 | \$871 | \$924 | 96 |
| 22" | 16" | 9C22-FF | \$916 | \$970 | \$1,025 | 108 |
| 28" | 16" | 9C28-FF | \$1,003 | \$1,058 | \$1,111 | 126 |

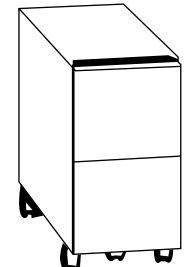

Mobile Pedestal

File/file -FF

SHIPS FULLY ASSEMBLED

NOTE: FOR LOCK ADD /L TO MODEL # AND ADD \$111 TO LIST.

Classic 23



Classic Collection



SERIES 900 - Free Standing Pedestals

Base Pedestal

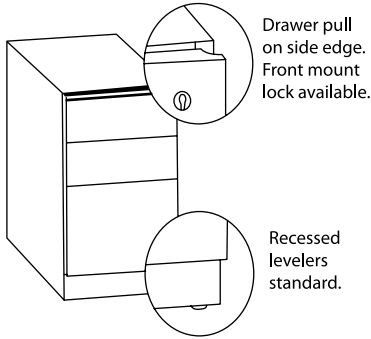

Drawer pull on side edge. Front mount lock available.

Recessed levelers standard.

Mobile Pedestal

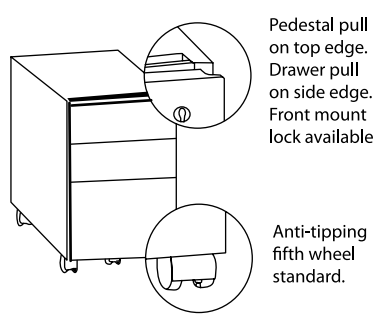

Pedestal pull on top edge. Drawer pull on side edge. Front mount lock available

Anti-tipping fifth wheel standard.

| D | W | 28"H / Model# | Zone 0 | Zone 1 | Zone 2 | WT |
|-----|-----|---------------|---------|---------|---------|-----|
| 18" | 16" | 9K18-BBBB | \$817 | \$871 | \$924 | 96 |
| 22" | 16" | 9K22-BBBB | \$916 | \$970 | \$1,025 | 108 |
| 28" | 16" | 9K28-BBBB | \$1,003 | \$1,058 | \$1,111 | 126 |

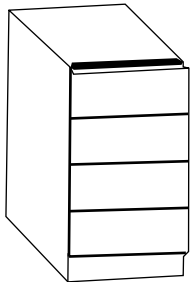

Base Pedestal

Box/box/box/box-BBBB

SHIPS FULLY ASSEMBLED

NOTE: FOR LOCK ADD /L TO MODEL # AND ADD \$111 TO LIST.

| D | W | 27"H / Model# | Zone 0 | Zone 1 | Zone 2 | WT |
|-----|-----|---------------|---------|---------|---------|-----|
| 18" | 16" | 9C18-BBBB | \$817 | \$871 | \$924 | 96 |
| 22" | 16" | 9C22-BBBB | \$916 | \$970 | \$1,025 | 108 |
| 28" | 16" | 9C28-BBBB | \$1,003 | \$1,058 | \$1,111 | 126 |

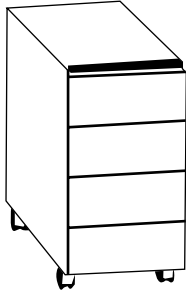

Mobile Pedestal

Box/box/box/box-BBBB

SHIPS FULLY ASSEMBLED

NOTE: FOR LOCK ADD /L TO MODEL # AND ADD \$111 TO LIST.

| D | W | 25"H / Model# | Zone 0 | Zone 1 | Zone 2 | WT |
|-----|-----|---------------|--------|--------|--------|----|
| 18" | 16" | 9K18-TBF | \$817 | \$871 | \$924 | 96 |

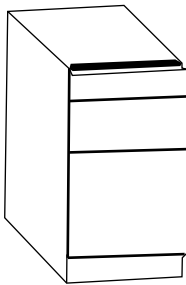

Base Pedestal

Tray/Box/File - T/B/F

Note: TBF is 25"H and 24"H caster

Locking-N/A

SHIPS FULLY ASSEMBLED

| D | W | 24"H / Model# | Zone 0 | Zone 1 | Zone 2 | WT |
|-----|-----|---------------|--------|--------|--------|----|
| 18" | 16" | 9C18-TBF | \$817 | \$871 | \$924 | 96 |

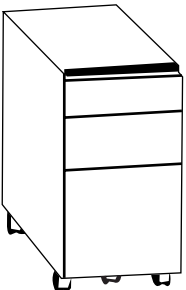

Mobile Pedestal

Tray/Box/File - T/B/F

Locking - N/A

SHIPS FULLY ASSEMBLED

Classic 24



SERIES 900 - Free Standing Pedestals

Base Pedestal

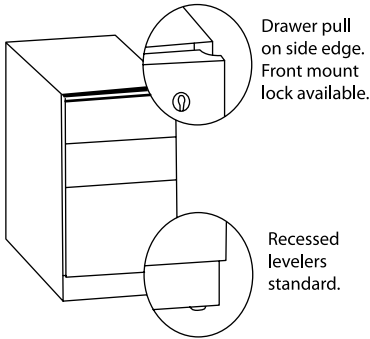

Drawer pull on side edge. Front mount lock available.

Recessed levelers standard.

Mobile Pedestal

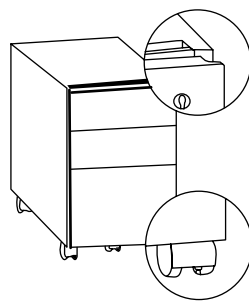

Pedestal pull on top edge. Drawer pull on side edge. Front mount lock available

Anti-tipping fifth wheel standard.

| D | W | 28"H / Model# | Zone 0 | Zone 1 | Zone 2 | WT |
|-----|-----|---------------|--------|--------|--------|----|
| 18" | 18" | 9K18-DS | \$791 | \$846 | \$900 | 84 |
| 18" | 22" | 9K22-DS | \$829 | \$886 | \$936 | 96 |

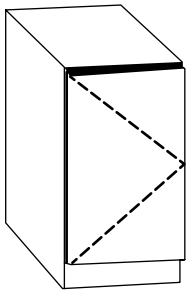

Base Pedestal

Door Storage / 1 shelf

Note: Specify Hinge **LEFT** or **RIGHT**

Extra Shelf add \$66 to List

FOR LOCK ADD /L TO MODEL # AND ADD \$111 TO LIST.

SHIPS FULLY ASSEMBLED

| D | W | 27"H / Model# | Zone 0 | Zone 1 | Zone 2 | WT |
|-----|-----|---------------|--------|--------|--------|----|
| 18" | 18" | 9C18-DS | \$791 | \$846 | \$900 | 84 |
| 18" | 22" | 9C22-DS | \$829 | \$886 | \$936 | 96 |

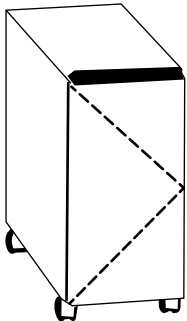

Mobile Pedestal

Door Storage / 1 shelf

Note: Specify Hinge **LEFT** or **RIGHT**

Extra Shelf add \$66 to List

FOR LOCK ADD /L TO MODEL # AND ADD \$111 TO LIST.

SHIPS FULLY ASSEMBLED

| D | W | 28"H / Model# | Zone 0 | Zone 1 | Zone 2 | WT |
|-----|-----|---------------|---------|---------|---------|-----|
| 18" | 18" | 9K18-DDS | \$1,168 | \$1,223 | \$1,278 | 120 |
| 18" | 22" | 9K22-DDS | \$1,239 | \$1,295 | \$1,348 | 138 |

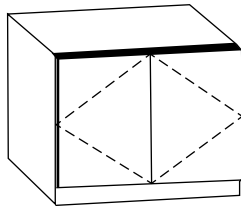

Base Pedestal

Note: "Extra Shelf" add \$110 to List

FOR LOCK ADD /L TO MODEL # AND ADD \$111 TO LIST.

SHIPS FULLY ASSEMBLED

| D | W | 27"H / Model# | Zone 0 | Zone 1 | Zone 2 | WT |
|-----|-----|---------------|---------|---------|---------|-----|
| 18" | 18" | 9C18-DDS | \$1,168 | \$1,223 | \$1,278 | 120 |
| 18" | 22" | 9C22-DDS | \$1,239 | \$1,295 | \$1,348 | 138 |

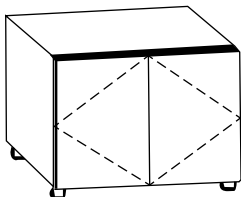

Base Pedestal

Note: "Extra Shelf" add \$110 to List

FOR LOCK ADD /L TO MODEL # AND ADD \$111 TO LIST.

SHIPS FULLY ASSEMBLED



Classic Collection



Edge

SERIES 900 - Lateral File Units

2 Drawer Lateral File

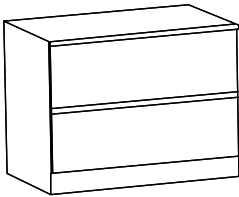

| D | W | H | Model# | Zone 0 | Zone 1 | Zone 2 | WT |
|-----|-----|-----|---------|---------|---------|---------|-----|
| 22" | 36" | 28" | 9K22L/L | \$1,518 | \$1,571 | \$1,623 | 210 |
| 22" | 30" | 28" | 9K02L/L | \$1,518 | \$1,571 | \$1,623 | 190 |

NOTE: All Units come standard with locks.
All units accommodate legal and letter size pendaflex files.
SHIPS FULLY ASSEMBLED

3 Drawer Lateral File

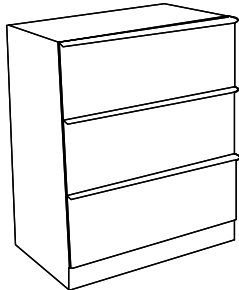

| D | W | H | Model# | Zone 0 | Zone 1 | Zone 2 | WT |
|-----|-----|-----|---------|---------|---------|---------|-----|
| 22" | 36" | 40" | 9K23L/L | \$2,123 | \$2,176 | \$2,228 | 270 |
| 22" | 30" | 40" | 9K03L/L | \$2,123 | \$2,176 | \$2,228 | 240 |

NOTE: All Units come standard with locks.
All units accommodate legal and letter size pendaflex files.
SHIPS FULLY ASSEMBLED

4 Drawer Lateral File

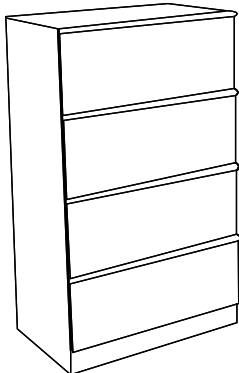

| D | W | H | Model# | Zone 0 | Zone 1 | Zone 2 | WT |
|-----|-----|-----|---------|---------|---------|---------|-----|
| 22" | 36" | 52" | 9K24L/L | \$2,559 | \$2,611 | \$2,663 | 360 |
| 22" | 30" | 52" | 9K04L/L | \$2,559 | \$2,611 | \$2,663 | 320 |

NOTE: All Units come standard with locks.
All units accommodate legal and letter size pendaflex files.
SHIPS FULLY ASSEMBLED

Classic 26



Curved Desk Specifications

Base Model

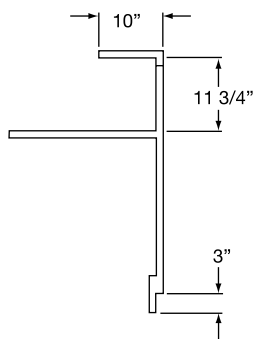

- Tops** 1 1/8" particle board covered on all exposed surfaces with high pressure laminate. Inside radius: 24". Outside radius: 48".
- End Panels** 2 3/8" particle board covered all exposed surfaces with high pressure laminate.
- Curved Front Panels** Curved framed construction. Covered on all exposed exterior and interior Surfaces with high pressure plastic laminate. Curved wall under worksurface is finished in only black.
- Recessed Base** 3" black, standard - chrome or brass finish optional
- Leveling Glides** Supplied on all units. Glides are adjustable.

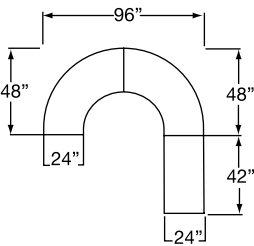

- Accent Strips** 1 / 8" accent strip in black, standard - chrome or brass finish optional
- Finishes** Check Finish Section of L.U.I.+PLUS catalog for availability and up-charges.
- Shipping** All units shipped disassembled in sections.
- Modifications** Other sizes and configurations are available. Consult factory
- Note:** Momentum Recessed Base - 3" oak, walnut, mahogany, black, maple or cherry. Momentum Accent Strips - 1/4" accent strip in oak, walnut, mahogany, black, maple or cherry - optional

Flush Model

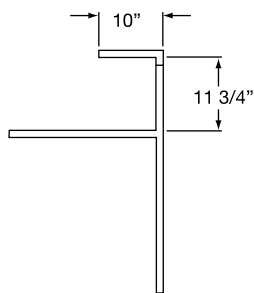

- Tops** 1 1/8" particle board covered on all exposed surfaces with high pressure laminate. Inside radius: 24". Outside radius: 48".
- End Panels** 1 1/4" particle board covered all exposed surfaces with high pressure laminate.
- Curved Front Panels** Curved framed construction. Covered on all exposed exterior and interior Surfaces with high pressure plastic laminate. Curved wall under worksurface is finished in only black.
- Recessed Base** Not available
- Leveling Glides** Supplied on all units. Glides are adjustable.

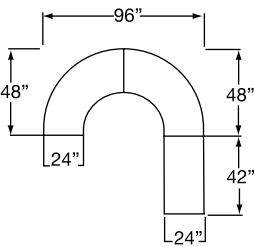

- Accent Strips** 1 / 8" accent strip in black, standard - chrome or brass finish optional
- Finishes** Check Finish Section of L.U.I.+PLUS catalog for availability and up-charges.
- Shipping** All units shipped disassembled in sections.
- Modifications** Other sizes and configurations are available. Consult factory
- Note:** Momentum Recessed Base - 3" oak, walnut, mahogany, black, maple or cherry. Momentum Accent Strips - 1/4" accent strip in oak, walnut, mahogany, black, maple or cherry - optional

Classic 27



Series 100 Base Curved Desks

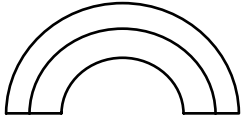

| 30" High Model# | Zone 0 | Zone 1 | Zone 2 | WT |
|--------------------|---------|---------|---------|-----|
| 1BC-B | \$7,578 | \$8,273 | \$8,748 | 600 |

42" High w/ Transaction Ledge

| Model# | Zone 0 | Zone 1 | Zone 2 | WT |
|---------|----------|----------|----------|-----|
| 1BC-B/L | \$11,061 | \$11,756 | \$12,231 | 600 |

Half Circle - Ships in TWO SECTIONS

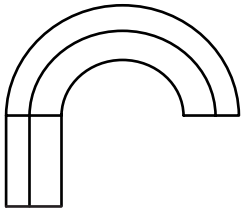

| 30" High Model# | Zone 0 | Zone 1 | Zone 2 | WT |
|--------------------|---------|---------|----------|-----|
| 1BRC-B | \$9,272 | \$9,966 | \$10,441 | 816 |

42" High w/ Transaction Ledge

| Model# | Zone 0 | Zone 1 | Zone 2 | WT |
|----------|----------|----------|----------|-----|
| 1BRC-B/L | \$13,505 | \$14,200 | \$14,675 | 816 |

Half Circle with **LEFT** return - Ships in THREE SECTIONS

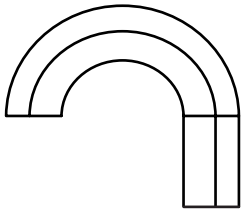

| 30" High Model# | Zone 0 | Zone 1 | Zone 2 | WT |
|--------------------|---------|---------|----------|-----|
| 1BCR-B | \$9,272 | \$9,966 | \$10,441 | 816 |

42" High w/ Transaction Ledge

| Model# | Zone 0 | Zone 1 | Zone 2 | WT |
|----------|----------|----------|----------|-----|
| 1BCR-B/L | \$13,505 | \$14,200 | \$14,675 | 816 |

Half Circle with **RIGHT** return - Ships in THREE SECTIONS

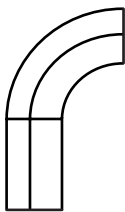

| 30" High Model# | Zone 0 | Zone 1 | Zone 2 | WT |
|--------------------|---------|---------|---------|-----|
| 1BRQ-B | \$6,078 | \$6,531 | \$7,006 | 540 |

42" High w/ Transaction Ledge

| Model# | Zone 0 | Zone 1 | Zone 2 | WT |
|----------|---------|---------|---------|-----|
| 1BRQ-B/L | \$8,607 | \$9,301 | \$9,776 | 540 |

Quarter Circle with **LEFT** return - Ships in TWO SECTIONS

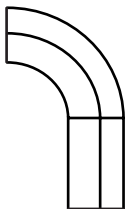

| 30" High Model# | Zone 0 | Zone 1 | Zone 2 | WT |
|--------------------|---------|---------|---------|-----|
| 1BQR-B | \$6,078 | \$6,531 | \$7,006 | 540 |

42" High w/ Transaction Ledge

| Model# | Zone 0 | Zone 1 | Zone 2 | WT |
|----------|---------|---------|---------|-----|
| 1BQR-B/L | \$8,607 | \$9,301 | \$9,776 | 540 |

Quarter Circle with **RIGHT** return - Ships in TWO SECTIONS

NOTE: Optional Accessories Refer to back of Pricelist



Series 100 Base Curved Desks

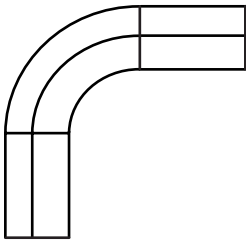

| 30" High Model# | Zone 0 | Zone 1 | Zone 2 | WT |
|--------------------|---------|---------|---------|-----|
| 1BRQR-B | \$7,433 | \$8,127 | \$8,602 | 780 |

| 42" High w/ Transaction Ledge Model# | Zone 0 | Zone 1 | Zone 2 | WT |
|---|----------|----------|----------|-----|
| 1BRQR-B/L | \$10,880 | \$11,574 | \$12,050 | 540 |

Quarter Circle w/ **LEFT & RIGHT** Return
Ships in THREE SECTIONS

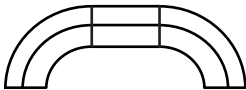

| 30" High Model# | Zone 0 | Zone 1 | Zone 2 | WT |
|--------------------|---------|----------|----------|-----|
| 1BQRQ-B | \$9,537 | \$10,232 | \$10,707 | 816 |

| 42" High w/ Transaction Ledge Model# | Zone 0 | Zone 1 | Zone 2 | WT |
|---|----------|----------|----------|-----|
| 1BQRQ-B/L | \$13,699 | \$14,393 | \$14,868 | 816 |

Two Quarter Circle w/ non - handed return
Ships in THREE SECTIONS

NOTES: Returns are standard at 29" executive height and 42" wide.

Gloss finish is available at 25% upcharge

The above pricing is for black reveal & base only.

When specifying chrome or brass. **(-C or -BR) ADD \$378 to LIST PRICE)**

Other configurations - Consult factory Customer Service for pricing and specifications on special configurations of Curved Desk Components.

NOTE: Optional Accessories Refer to back of Pricelist

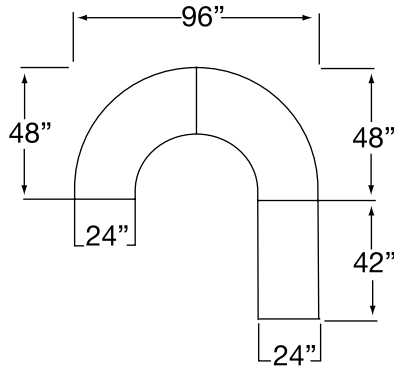



Classic Collection



Edge

Series 100 Flush Curved Desks (No Base)

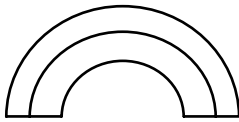

| 30" High Model# | Zone 0 | Zone 1 | Zone 2 | WT |
|--------------------|---------|---------|---------|-----|
| 1FC-B | \$5,485 | \$6,180 | \$6,655 | 525 |

| 42" High w/ Transaction Ledge Model# | Zone 0 | Zone 1 | Zone 2 | WT |
|---|---------|---------|---------|-----|
| 1FC-B/L | \$8,098 | \$8,792 | \$9,267 | 525 |

Half Circle - Ships in TWO SECTIONS

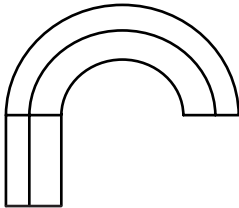

| 30" High Model# | Zone 0 | Zone 1 | Zone 2 | WT |
|--------------------|---------|---------|---------|-----|
| 1FRC-B | \$6,937 | \$7,631 | \$8,106 | 690 |

| 42" High w/ Transaction Ledge Model# | Zone 0 | Zone 1 | Zone 2 | WT |
|---|----------|----------|----------|-----|
| 1FRC-B/L | \$10,178 | \$10,873 | \$11,349 | 690 |

Half Circle with **LEFT** return - Ships in THREE SECTIONS

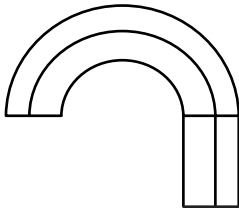

| 30" High Model# | Zone 0 | Zone 1 | Zone 2 | WT |
|--------------------|---------|---------|---------|-----|
| 1FCR-B | \$6,937 | \$7,631 | \$8,106 | 690 |

| 42" High w/ Transaction Ledge Model# | Zone 0 | Zone 1 | Zone 2 | WT |
|---|----------|----------|----------|-----|
| 1FCR-B/L | \$10,178 | \$10,873 | \$11,349 | 690 |

Half Circle with **RIGHT** return - Ships in THREE SECTIONS

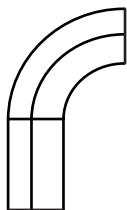

| 30" High Model# | Zone 0 | Zone 1 | Zone 2 | WT |
|--------------------|---------|---------|---------|-----|
| 1FRQ-B | \$4,071 | \$4,765 | \$5,240 | 468 |

| 42" High w/ Transaction Ledge Model# | Zone 0 | Zone 1 | Zone 2 | WT |
|---|---------|---------|---------|-----|
| 1FRQ-B/L | \$6,090 | \$6,785 | \$7,260 | 468 |

Quarter Circle with **LEFT** return - Ships in TWO SECTIONS

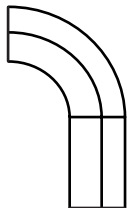

| 30" High Model# | Zone 0 | Zone 1 | Zone 2 | WT |
|--------------------|---------|---------|---------|-----|
| 1FQR-B | \$4,071 | \$4,765 | \$5,240 | 468 |

| 42" High w/ Transaction Ledge Model# | Zone 0 | Zone 1 | Zone 2 | WT |
|---|---------|---------|---------|-----|
| 1FQR-B/L | \$6,090 | \$6,785 | \$7,260 | 468 |

Quarter Circle with **RIGHT** return - Ships in TWO SECTIONS

NOTE: Optional Accessories Refer to back of Pricelist

Classic 30



Series 100 Flush Curved Desks (No Base)

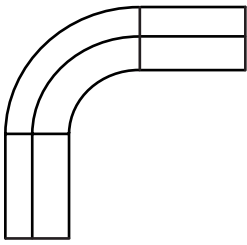

| 30" High Model# | Zone 0 | Zone 1 | Zone 2 | WT |
|--------------------|---------|---------|---------|-----|
| 1FRQR-B | \$5,255 | \$5,950 | \$6,425 | 624 |

| 42" High w/ Transaction Ledge Model# | Zone 0 | Zone 1 | Zone 2 | WT |
|--|---------|---------|---------|-----|
| 1FRQR-B/L | \$7,784 | \$8,478 | \$8,953 | 624 |

Quarter Circle w/ **LEFT & RIGHT** Return
Ships in **THREE SECTIONS**

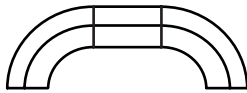

| 30" High Model# | Zone 0 | Zone 1 | Zone 2 | WT |
|--------------------|---------|---------|---------|-----|
| 1FQRQ-B | \$7,143 | \$7,836 | \$8,313 | 690 |

| 42" High w/ Transaction Ledge Model# | Zone 0 | Zone 1 | Zone 2 | WT |
|--|----------|----------|----------|-----|
| 1FQRQ-B/L | \$10,349 | \$11,042 | \$11,518 | 690 |

Two Quarter Circle w/ non - handed return
Ships in **THREE SECTIONS**

NOTES: Returns are standard at 29" executive height and 42" wide.

Gloss finish is available at 25% upcharge

The above pricing is for black reveal & base only.

When specifying chrome or brass. **(-C or -BR) ADD \$378 to LIST PRICE)**

Other configurations - Consult factory Customer Service for pricing and specifications on special configurations of Curved Desk Components.

NOTE: Optional Accessories Refer to back of Pricelist

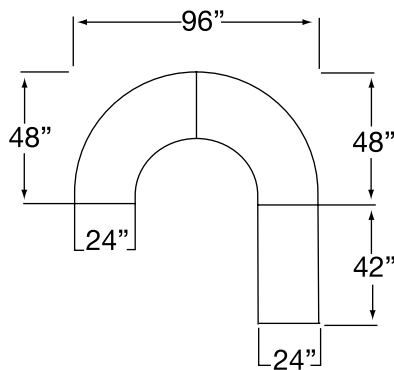

Classic 31



Momentum Solid Wood Edge Base Curved Desks

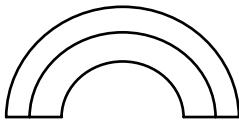

| 30" High | | | | |
|----------|----------|----------|----------|-----|
| Model# | Zone 0 | Zone 1 | Zone 2 | WT |
| WBC | \$10,470 | \$11,163 | \$11,638 | 735 |

| 42" High w/ Transaction Ledge | | | | |
|-------------------------------|----------|----------|----------|-----|
| Model# | Zone 0 | Zone 1 | Zone 2 | WT |
| WBC/L | \$15,150 | \$15,845 | \$16,320 | 735 |

Half Circle - Ships in TWO SECTIONS

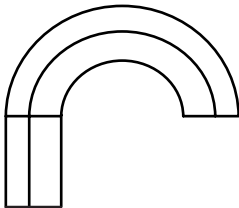

| 30" High | | | | |
|----------|----------|----------|----------|-------|
| Model# | Zone 0 | Zone 1 | Zone 2 | WT |
| WBRC | \$13,094 | \$13,788 | \$14,264 | 1,020 |

| 42" High w/ Transaction Ledge | | | | |
|-------------------------------|----------|----------|----------|-------|
| Model# | Zone 0 | Zone 1 | Zone 2 | WT |
| WBRC/L | \$18,791 | \$19,485 | \$19,961 | 1,020 |

Half Circle with **LEFT** return - Ships in THREE SECTIONS

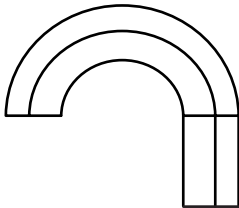

| 30" High | | | | |
|----------|----------|----------|----------|-------|
| Model# | Zone 0 | Zone 1 | Zone 2 | WT |
| WBCR | \$13,094 | \$13,788 | \$14,264 | 1,020 |

| 42" High w/ Transaction Ledge | | | | |
|-------------------------------|----------|----------|----------|-------|
| Model# | Zone 0 | Zone 1 | Zone 2 | WT |
| WBCR/L | \$18,791 | \$19,485 | \$19,961 | 1,020 |

Half Circle with **RIGHT** return - Ships in THREE SECTIONS



| 30" High | | | | |
|----------|---------|---------|---------|-----|
| Model# | Zone 0 | Zone 1 | Zone 2 | WT |
| WBRQ | \$8,461 | \$9,155 | \$9,630 | 675 |

| 42" High w/ Transaction Ledge | | | | |
|-------------------------------|----------|----------|----------|-----|
| Model# | Zone 0 | Zone 1 | Zone 2 | WT |
| WBRQ/L | \$12,187 | \$12,881 | \$13,356 | 675 |

Quarter Circle with **LEFT** return - Ships in TWO SECTIONS

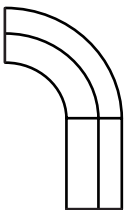

| 30" High | | | | |
|----------|---------|---------|---------|-----|
| Model# | Zone 0 | Zone 1 | Zone 2 | WT |
| WBQR | \$8,461 | \$9,155 | \$9,630 | 675 |

| 42" High w/ Transaction Ledge | | | | |
|-------------------------------|----------|----------|----------|-----|
| Model# | Zone 0 | Zone 1 | Zone 2 | WT |
| WBQR/L | \$12,187 | \$12,881 | \$13,356 | 675 |

Quarter Circle with **RIGHT** return - Ships in TWO SECTIONS

NOTE: Optional Accessories Refer to back of Pricelist



Momentum Solid Wood Edge Base Curved Desks

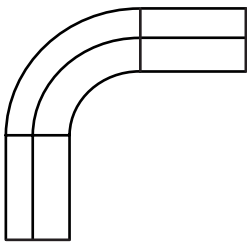

| 30" High Model# | Zone 0 | Zone 1 | Zone 2 | WT |
|--------------------|----------|----------|----------|-----|
| WBRQR | \$10,602 | \$11,297 | \$11,772 | 975 |

| 42" High w/ Transaction Ledge Model# | Zone 0 | Zone 1 | Zone 2 | WT |
|---|----------|----------|----------|-----|
| WBRQR/L | \$15,247 | \$15,941 | \$16,417 | 975 |

Quarter Circle w/ **LEFT & RIGHT** Return
Ships in THREE SECTIONS

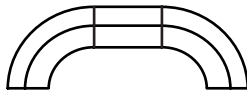

| 30" High Model# | Zone 0 | Zone 1 | Zone 2 | WT |
|--------------------|----------|----------|----------|-------|
| WBQRQ | \$13,433 | \$14,126 | \$14,603 | 1,020 |

| 42" High w/ Transaction Ledge Model# | Zone 0 | Zone 1 | Zone 2 | WT |
|---|----------|----------|----------|-------|
| WBQRQ/L | \$19,045 | \$19,739 | \$20,214 | 1,020 |

Two Quarter Circle w/ non - handed return
Ships in THREE SECTIONS

NOTES: Returns are standard at 29" executive height and 42" wide.

Gloss finish is available at 25% upcharge

Other configurations - Consult factory Customer Service for pricing and specifications on special configurations of Curved Desk Components.

NOTE: Optional Accessories Refer to back of Pricelist

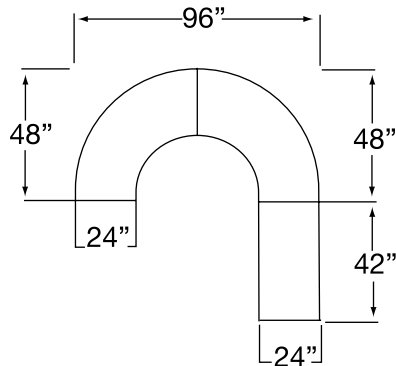



Momentum Solid Wood Edge Flush Curved Desks (No Base)

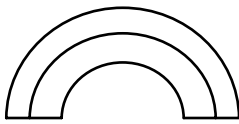

| 30" High Model# | Zone 0 | Zone 1 | Zone 2 | WT |
|-----------------|---------|---------|---------|-----|
| WFC | \$7,627 | \$8,320 | \$8,797 | 625 |

| 42" High w/ Transaction Ledge Model# | Zone 0 | Zone 1 | Zone 2 | WT |
|--------------------------------------|----------|----------|----------|-----|
| WFC/L | \$11,159 | \$11,853 | \$12,328 | 735 |

Half Circle - Ships in TWO SECTIONS

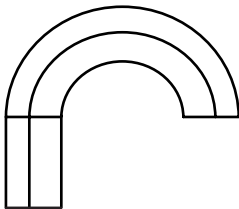

| 30" High Model# | Zone 0 | Zone 1 | Zone 2 | WT |
|-----------------|---------|----------|----------|-----|
| WFRC | \$9,937 | \$10,632 | \$11,107 | 863 |

| 42" High w/ Transaction Ledge Model# | Zone 0 | Zone 1 | Zone 2 | WT |
|--------------------------------------|----------|----------|----------|-----|
| WFRC/L | \$14,292 | \$14,986 | \$15,461 | 863 |

Half Circle with **LEFT** return - Ships in THREE SECTIONS

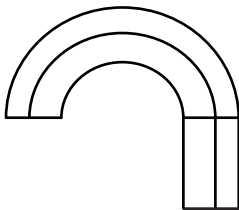

| 30" High Model# | Zone 0 | Zone 1 | Zone 2 | WT |
|-----------------|---------|----------|----------|-----|
| WFCR | \$9,937 | \$10,632 | \$11,107 | 863 |

| 42" High w/ Transaction Ledge Model# | Zone 0 | Zone 1 | Zone 2 | WT |
|--------------------------------------|----------|----------|----------|-----|
| WFCR/L | \$14,292 | \$14,986 | \$15,461 | 863 |

Half Circle with **RIGHT** return - Ships in THREE SECTIONS

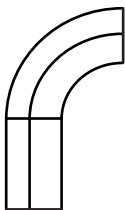

| 30" High Model# | Zone 0 | Zone 1 | Zone 2 | WT |
|-----------------|---------|---------|---------|-----|
| WFRQ | \$6,066 | \$6,761 | \$7,236 | 585 |

| 42" High w/ Transaction Ledge Model# | Zone 0 | Zone 1 | Zone 2 | WT |
|--------------------------------------|---------|---------|---------|-----|
| WFRQ/L | \$8,788 | \$9,482 | \$9,958 | 585 |

Quarter Circle with **LEFT** return - Ships in TWO SECTIONS

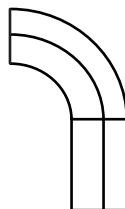

| 30" High Model# | Zone 0 | Zone 1 | Zone 2 | WT |
|-----------------|---------|---------|---------|-----|
| WFQR | \$6,066 | \$6,761 | \$7,236 | 585 |

| 42" High w/ Transaction Ledge Model# | Zone 0 | Zone 1 | Zone 2 | WT |
|--------------------------------------|---------|---------|---------|-----|
| WFQR/L | \$8,788 | \$9,482 | \$9,958 | 585 |

Quarter Circle with **RIGHT** return - Ships in TWO SECTIONS

NOTE: Optional Accessories Refer to back of Pricelist

Classic 34



Momentum Solid Wood Edge Flush Curved Desks (No Base)

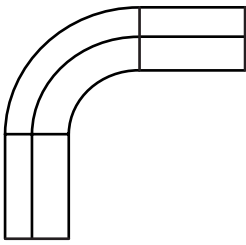

30" High

| Model# | Zone 0 | Zone 1 | Zone 2 | WT |
|--------|---------|---------|---------|-----|
| WFRQR | \$7,663 | \$8,357 | \$8,832 | 780 |

42" High w/ Transaction Ledge

| Model# | Zone 0 | Zone 1 | Zone 2 | WT |
|---------|----------|----------|----------|-----|
| WFRQR/L | \$11,061 | \$11,756 | \$12,231 | 975 |

Quarter Circle w/ **LEFT & RIGHT** Return
Ships in THREE SECTIONS

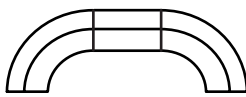

30" High

| Model# | Zone 0 | Zone 1 | Zone 2 | WT |
|--------|----------|----------|----------|-----|
| WFQRQ | \$10,215 | \$10,909 | \$11,384 | 863 |

42" High w/ Transaction Ledge

| Model# | Zone 0 | Zone 1 | Zone 2 | WT |
|---------|----------|----------|----------|-----|
| WFQRQ/L | \$14,522 | \$15,215 | \$15,691 | 863 |

Two Quarter Circle w/ non - handed return
Ships in THREE SECTIONS

NOTES: Returns are standard at 29" executive height and 42" wide.

Gloss finish is available at 25% upcharge

Other configurations - Consult factory Customer Service for pricing and specifications on special configurations of Curved Desk Components.

NOTE: Optional Accessories Refer to back of Pricelist

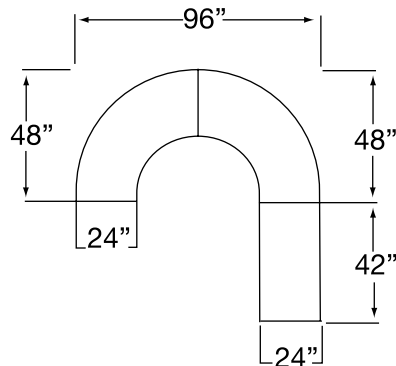



Reception Desk Specifications - Series 110

- Tops & End Panels** 1 1/8" particle board covered on all surfaces with high pressure laminate

- Front Panel** 3/4" particle board covered on all exposed surfaces with high pressure laminate

- Drawers** All wood construction. All exposed surfaces covered with black vinyl.

- File Drawers** Mounted on full extension slides. Accommodates letter or legal size filing.

- Box Drawers** Mounted on full extension slides

- Leveling Glides** Supplied on all units. Glides are adjustable.

- Keying** Standard production is to random key all units

- Keying Alike** Units are needed keyed alike should be specified on order / Purchase Order# (No upcharge)

- Master Keying** Is available on any number of units up to 50 different keys with 1 master key. Master keying should be specified, UPCHARGE \$65 (Master Keys are not shipped with furniture, but sent to ordering dealer or designated agent).

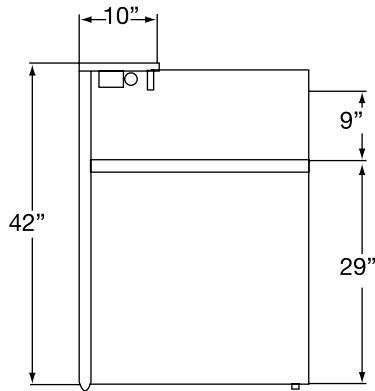



Classic Collection



Edge

Reception Desk Specifications - Series 110

42" High w/ Ledge

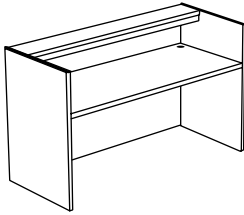

| D | W | Model # | Zone 0 | Zone 1 | Zone 2 | WT |
|-----|-----|---------|---------|---------|---------|-----|
| 30" | 84" | 14R04 | \$2,352 | \$2,563 | \$2,712 | 375 |
| 30" | 72" | 14R02 | \$2,196 | \$2,406 | \$2,554 | 360 |
| 30" | 66" | 14R06 | \$2,123 | \$2,333 | \$2,482 | 348 |
| 30" | 60" | 14R00 | \$1,989 | \$2,199 | \$2,349 | 276 |

Desk 42"H

SHIPS FULLY ASSEMBLED

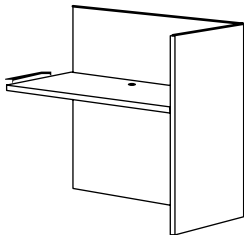

| D | W | Model # | Zone 0 | Zone 1 | Zone 2 | WT |
|-----|-----|---------|---------|---------|---------|-----|
| 20" | 54" | 14R540 | \$1,675 | \$1,849 | \$1,962 | 300 |
| 20" | 48" | 14R480 | \$1,506 | \$1,680 | \$1,793 | 255 |
| 20" | 42" | 14R420 | \$1,482 | \$1,632 | \$1,744 | 240 |
| 20" | 36" | 14R360 | \$1,458 | \$1,607 | \$1,720 | 225 |
| 24" | 54" | 14R544 | \$1,712 | \$1,886 | \$1,998 | 315 |
| 24" | 48" | 14R484 | \$1,542 | \$1,716 | \$1,828 | 263 |
| 24" | 42" | 14R424 | \$1,494 | \$1,669 | \$1,781 | 248 |
| 24" | 36" | 14R364 | \$1,458 | \$1,632 | \$1,744 | 233 |

RIGHT Returns 42" with Worksurface at 29"H

SHIPS FULLY ASSEMBLED

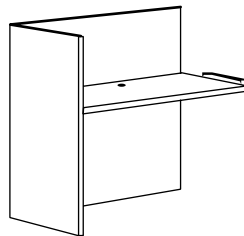

| D | W | Model # | Zone 0 | Zone 1 | Zone 2 | WT |
|-----|-----|---------|---------|---------|---------|-----|
| 20" | 54" | 14L540 | \$1,675 | \$1,849 | \$1,962 | 300 |
| 20" | 48" | 14L480 | \$1,506 | \$1,680 | \$1,793 | 255 |
| 20" | 42" | 14L420 | \$1,482 | \$1,632 | \$1,744 | 240 |
| 20" | 36" | 14L360 | \$1,458 | \$1,607 | \$1,720 | 225 |
| 24" | 54" | 14L544 | \$1,712 | \$1,886 | \$1,998 | 315 |
| 24" | 48" | 14L484 | \$1,542 | \$1,716 | \$1,828 | 263 |
| 24" | 42" | 14L424 | \$1,494 | \$1,669 | \$1,781 | 248 |
| 24" | 36" | 14L364 | \$1,458 | \$1,632 | \$1,744 | 233 |

LEFT Returns 42" with Worksurface at 29"H

SHIPS FULLY ASSEMBLED

NOTE: Task Light standard with desks

All desks come standard with cable -cut out, with cover on right and left corners.

All returns come standard with cable -cut out with cover, in center back.

If using **LEFT** and **RIGHT** returns to form U-shaped unit, use 20" returns with

72" and 84" desks only to allow adequate kneespace.

Classic 37



Series 800 Panel End Parsons Table (Indicate desired height after model number)

Solid Colors
Seamless Construction

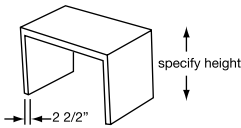

| D | W | Panel End # | Zone 0 | Zone 1 | Zone 2 | WT |
|-----|-----|-------------|---------|---------|---------|-----|
| 12" | 48" | 8EO-4812 | \$659 | \$748 | \$897 | 70 |
| 12" | 60" | 8EO-6012 | \$756 | \$846 | \$995 | 75 |
| 12" | 72" | 8EO-7212 | \$926 | \$1,015 | \$1,163 | 80 |
| 12" | 84" | 8EO-8412 | \$1,095 | \$1,184 | \$1,333 | 85 |
| 18" | 48" | 8EO-4818 | \$961 | \$1,051 | \$1,200 | 84 |
| 18" | 60" | 8EO-6018 | \$1,179 | \$1,269 | \$1,418 | 90 |
| 18" | 72" | 8EO-7218 | \$1,445 | \$1,535 | \$1,684 | 96 |
| 18" | 84" | 8EO-8418 | \$1,663 | \$1,753 | \$1,902 | 102 |
| 24" | 24" | 8EO-2424 | \$659 | \$750 | \$899 | 80 |
| 24" | 36" | 8EO-3624 | \$914 | \$1,002 | \$1,151 | 88 |
| 24" | 48" | 8EO-4824 | \$1,252 | \$1,341 | \$1,490 | 96 |
| 24" | 60" | 8EO-6024 | \$1,579 | \$1,668 | \$1,817 | 115 |
| 24" | 84" | 8EO-8424 | \$2,268 | \$2,358 | \$2,507 | 136 |
| 30" | 30" | 8EO-3030 | \$1,095 | \$1,184 | \$1,333 | 105 |
| 30" | 48" | 8EO-4830 | \$2,184 | \$2,272 | \$2,421 | 120 |
| 30" | 60" | 8EO-6030 | \$2,352 | \$2,442 | \$2,591 | 150 |
| 30" | 72" | 8EO-7230 | \$2,594 | \$2,684 | \$2,833 | 160 |
| 36" | 36" | 8EO-3636 | \$1,421 | \$1,511 | \$1,660 | 132 |
| 36" | 48" | 8EO-4836 | \$2,256 | \$2,346 | \$2,494 | 144 |
| 36" | 60" | 8EO-6036 | \$2,438 | \$2,527 | \$2,675 | 180 |
| 36" | 72" | 8EO-7236 | \$2,921 | \$3,011 | \$3,159 | 192 |
| 48" | 48" | 8EO-4848 | \$2,594 | \$2,685 | \$2,833 | 192 |

Series 800 4-Leg Parsons Table (Indicate desired height after model number)

Solid Colors
Seamless Construction

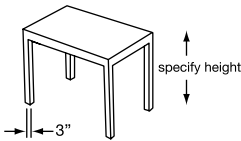

| D | W | Parson # | Zone 0 | Zone 1 | Zone 2 | WT |
|-----|-----|----------|---------|---------|---------|-----|
| 12" | 48" | 8PO-4812 | \$659 | \$748 | \$897 | 40 |
| 12" | 60" | 8PO-6012 | \$756 | \$846 | \$995 | 45 |
| 12" | 72" | 8PO-7212 | \$926 | \$1,015 | \$1,163 | 50 |
| 12" | 84" | 8PO-8412 | \$1,095 | \$1,184 | \$1,333 | 55 |
| 18" | 48" | 8PO-4818 | \$961 | \$1,051 | \$1,200 | 50 |
| 18" | 60" | 8PO-6018 | \$1,179 | \$1,269 | \$1,418 | 60 |
| 18" | 72" | 8PO-7218 | \$1,445 | \$1,535 | \$1,684 | 65 |
| 18" | 84" | 8PO-8418 | \$1,663 | \$1,753 | \$1,902 | 72 |
| 24" | 24" | 8PO-2424 | \$659 | \$750 | \$899 | 40 |
| 24" | 36" | 8PO-3624 | \$914 | \$1,002 | \$1,151 | 50 |
| 24" | 48" | 8PO-4824 | \$1,252 | \$1,341 | \$1,490 | 60 |
| 24" | 60" | 8PO-6024 | \$1,579 | \$1,668 | \$1,817 | 70 |
| 24" | 84" | 8PO-8424 | \$2,268 | \$2,358 | \$2,507 | 90 |
| 30" | 30" | 8PO-3030 | \$1,095 | \$1,184 | \$1,333 | 51 |
| 30" | 48" | 8PO-4830 | \$2,184 | \$2,272 | \$2,421 | 70 |
| 30" | 60" | 8PO-6030 | \$2,352 | \$2,442 | \$2,591 | 82 |
| 30" | 72" | 8PO-7230 | \$2,594 | \$2,684 | \$2,833 | 95 |
| 36" | 36" | 8PO-3636 | \$1,421 | \$1,511 | \$1,660 | 65 |
| 36" | 48" | 8PO-4836 | \$2,256 | \$2,346 | \$2,494 | 80 |
| 36" | 60" | 8PO-6036 | \$2,438 | \$2,527 | \$2,675 | 95 |
| 36" | 72" | 8PO-7236 | \$2,921 | \$3,011 | \$3,159 | 110 |
| 48" | 48" | 8PO-4848 | \$2,594 | \$2,685 | \$2,833 | 100 |

NOTE: Specify required height("H) when ordering. Prices reflect up to 30" height.

31"H to 36"H add 12% to List Price

37"H to 42"H add 20% to List Price

Casters on tables smaller than 18"D x 60"W - **ADD \$313 to LIST**

Intermediate sizes available. Consult factory

Center drawers available. Consult factory.

SHIPS FULLY ASSEMBLED

Classic 38



Classic Collection



Edge

Series 800 Panel End Parsons Table (Indicate desired height after model number)

Woodgrain
Mitered Corner
Construction

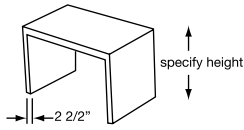

| D | W | Panel End # | Zone 0 | Zone 1 | Zone 2 | WT |
|-----|-----|-------------|---------|---------|---------|-----|
| 12" | 48" | 8ES-4812 | \$465 | \$555 | \$704 | 70 |
| 12" | 60" | 8ES-6012 | \$526 | \$616 | \$765 | 75 |
| 12" | 72" | 8ES-7212 | \$647 | \$737 | \$886 | 80 |
| 12" | 84" | 8ES-8412 | \$768 | \$858 | \$1,007 | 85 |
| 18" | 48" | 8ES-4818 | \$684 | \$773 | \$921 | 84 |
| 18" | 60" | 8ES-6018 | \$696 | \$785 | \$934 | 90 |
| 18" | 72" | 8ES-7218 | \$1,010 | \$1,099 | \$1,248 | 96 |
| 18" | 84" | 8ES-8418 | \$1,203 | \$1,293 | \$1,442 | 102 |
| 24" | 24" | 8ES-2424 | \$465 | \$555 | \$704 | 80 |
| 24" | 36" | 8ES-3624 | \$647 | \$737 | \$886 | 88 |
| 24" | 48" | 8ES-4824 | \$901 | \$990 | \$1,139 | 96 |
| 24" | 60" | 8ES-6024 | \$1,131 | \$1,220 | \$1,369 | 115 |
| 24" | 84" | 8ES-8424 | \$1,626 | \$1,716 | \$1,865 | 136 |
| 30" | 30" | 8ES-3030 | \$756 | \$846 | \$995 | 105 |
| 30" | 48" | 8ES-4830 | \$1,156 | \$1,244 | \$1,393 | 120 |
| 30" | 60" | 8ES-6030 | \$1,506 | \$1,595 | \$1,744 | 150 |
| 30" | 72" | 8ES-7230 | \$1,917 | \$2,007 | \$2,168 | 160 |
| 36" | 36" | 8ES-3636 | \$1,010 | \$1,099 | \$1,248 | 132 |
| 36" | 48" | 8ES-4836 | \$1,373 | \$1,462 | \$1,611 | 144 |
| 36" | 60" | 8ES-6036 | \$1,747 | \$1,837 | \$1,986 | 180 |
| 36" | 72" | 8ES-7236 | \$2,098 | \$2,188 | \$2,337 | 192 |
| 48" | 48" | 8ES-4848 | \$1,868 | \$1,970 | \$2,107 | 192 |

Series 800 4-Leg Parsons Table (Indicate desired height after model number)

Solid Colors
Mitered Corner
Construction

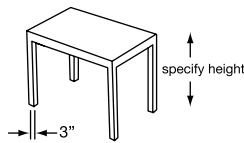

| D | W | Parson # | Zone 0 | Zone 1 | Zone 2 | WT |
|-----|-----|----------|---------|---------|---------|-----|
| 12" | 48" | 8PS-4812 | \$465 | \$555 | \$704 | 40 |
| 12" | 60" | 8PS-6012 | \$526 | \$616 | \$765 | 45 |
| 12" | 72" | 8PS-7212 | \$647 | \$737 | \$886 | 50 |
| 12" | 84" | 8PS-8412 | \$768 | \$858 | \$1,007 | 55 |
| 18" | 48" | 8PS-4818 | \$684 | \$773 | \$921 | 50 |
| 18" | 60" | 8PS-6018 | \$696 | \$785 | \$934 | 60 |
| 18" | 72" | 8PS-7218 | \$1,010 | \$1,099 | \$1,248 | 65 |
| 18" | 84" | 8PS-8418 | \$1,203 | \$1,293 | \$1,442 | 72 |
| 24" | 24" | 8PS-2424 | \$465 | \$555 | \$704 | 40 |
| 24" | 36" | 8PS-3624 | \$647 | \$737 | \$886 | 50 |
| 24" | 48" | 8PS-4824 | \$901 | \$990 | \$1,139 | 60 |
| 24" | 60" | 8PS-6024 | \$1,131 | \$1,220 | \$1,369 | 70 |
| 24" | 84" | 8PS-8424 | \$1,626 | \$1,716 | \$1,865 | 90 |
| 30" | 30" | 8PS-3030 | \$756 | \$846 | \$995 | 51 |
| 30" | 48" | 8PS-4830 | \$1,156 | \$1,244 | \$1,393 | 70 |
| 30" | 60" | 8PS-6030 | \$1,506 | \$1,595 | \$1,744 | 82 |
| 30" | 72" | 8PS-7230 | \$1,917 | \$2,007 | \$2,168 | 95 |
| 36" | 36" | 8PS-3636 | \$1,010 | \$1,099 | \$1,248 | 65 |
| 36" | 48" | 8PS-4836 | \$1,373 | \$1,462 | \$1,611 | 80 |
| 36" | 60" | 8PS-6036 | \$1,747 | \$1,837 | \$1,986 | 95 |
| 36" | 72" | 8PS-7236 | \$2,098 | \$2,188 | \$2,337 | 110 |
| 48" | 48" | 8PS-4848 | \$1,868 | \$1,970 | \$2,107 | 100 |

NOTE: Specify required height("H) when ordering. Prices reflect up to 30" height.

31"H to 36"H add 12% to List Price

37"H to 42"H add 20% to List Price

Casters on tables smaller than 18"D x 60"W - **ADD \$313 to LIST**

Intermediate sizes available. Consult factory

Center drawers available. Consult factory.

SHIPS FULLY ASSEMBLED

Classic 39



Classic Collection



Edge

Series 600 Cube Tables - Indicate desired height after model number

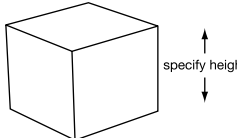

| | | 12" - 18" High | | | | | |
|-----|-----|----------------|--------|--------|--------|----|--|
| D | W | Model # | Zone 0 | Zone 1 | Zone 2 | WT | |
| 42" | 42" | 6F-4242 | \$768 | \$834 | \$886 | 78 | |
| 36" | 36" | 6F-3636 | \$611 | \$676 | \$728 | 63 | |
| 48" | 30" | 6F-3048 | \$598 | \$664 | \$716 | 60 | |
| 30" | 30" | 6F-3030 | \$502 | \$567 | \$619 | 54 | |
| 60" | 24" | 6F-2460 | \$647 | \$713 | \$765 | 65 | |
| 48" | 24" | 6F-2448 | \$551 | \$616 | \$667 | 55 | |
| 36" | 24" | 6F-2436 | \$502 | \$567 | \$619 | 46 | |
| 24" | 24" | 6F-2424 | \$393 | \$458 | \$511 | 38 | |
| 60" | 18" | 6F-1860 | \$598 | \$664 | \$716 | 58 | |
| 48" | 18" | 6F-1848 | \$526 | \$592 | \$644 | 50 | |
| 36" | 18" | 6F-1836 | \$417 | \$483 | \$535 | 41 | |
| 24" | 18" | 6F-1824 | \$321 | \$386 | \$437 | 36 | |
| 18" | 18" | 6F-1818 | \$296 | \$362 | \$414 | 30 | |

NOTE: Without Recessed Base

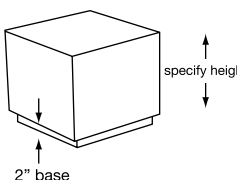

| | | 12" - 18" High | | | | | |
|-----|-----|----------------|--------|---------|---------|----|--|
| D | W | Model # | Zone 0 | Zone 1 | Zone 2 | WT | |
| 42" | 42" | 6B-4242 | \$986 | \$1,051 | \$1,103 | 85 | |
| 36" | 36" | 6B-3636 | \$805 | \$921 | \$947 | 68 | |
| 48" | 30" | 6B-3048 | \$792 | \$858 | \$909 | 66 | |
| 30" | 30" | 6B-3030 | \$684 | \$748 | \$800 | 59 | |
| 60" | 24" | 6B-2460 | \$780 | \$846 | \$897 | 71 | |
| 48" | 24" | 6B-2448 | \$732 | \$797 | \$849 | 61 | |
| 36" | 24" | 6B-2436 | \$671 | \$737 | \$788 | 50 | |
| 24" | 24" | 6B-2424 | \$502 | \$567 | \$619 | 42 | |
| 60" | 18" | 6B-1860 | \$756 | \$821 | \$874 | 64 | |
| 48" | 18" | 6B-1848 | \$672 | \$737 | \$788 | 55 | |
| 36" | 18" | 6B-1836 | \$598 | \$664 | \$716 | 44 | |
| 24" | 18" | 6B-1824 | \$465 | \$531 | \$583 | 40 | |
| 18" | 18" | 6B-1818 | \$430 | \$495 | \$546 | 32 | |

NOTE: With Recessed Base

Optional: (In lieu of standard black)

| | Model # | Price |
|--------------------|---------|-------|
| Chrome Recess Base | CRB | \$147 |
| Brass Recess Base | BRB | \$147 |

NOTE: Specify required height("H) in description when ordering. Prices reflect up to 18" high.

19"H to 24"H add 15% to List Price

25"H to 30"H add 20% to List Price

Intermediate sizes available. Consult factory

SHIPS FULLY ASSEMBLED

Classic 40



Radius & Drum Table - Indicate desired height after model number

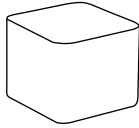

| 12" - 18" High | | | | | | |
|----------------|-----|---------|---------|---------|---------|----|
| D | W | Model # | Zone 0 | Zone 1 | Zone 2 | WT |
| 36" | 36" | 5F-3636 | \$1,058 | \$1,123 | \$1,176 | 86 |
| 30" | 30" | 5F-3030 | \$901 | \$967 | \$1,018 | 72 |
| 24" | 36" | 5F-2436 | \$877 | \$942 | \$995 | 58 |
| 24" | 24" | 5F-2424 | \$768 | \$834 | \$886 | 48 |
| 18" | 24" | 5F-1824 | \$647 | \$713 | \$765 | 42 |
| 18" | 18" | 5F-1818 | \$598 | \$664 | \$716 | 36 |

Without Recessed Base

SHIPS FULLY ASSEMBLED

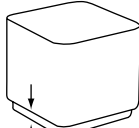

| 12" - 18" High | | | | | | |
|----------------|-----|---------|---------|---------|---------|-----|
| D | W | Model # | Zone 0 | Zone 1 | Zone 2 | WT |
| 36" | 36" | 5B-3636 | \$1,361 | \$1,426 | \$1,479 | 102 |
| 30" | 30" | 5B-3030 | \$1,179 | \$1,244 | \$1,297 | 84 |
| 24" | 36" | 5B-2436 | \$1,167 | \$1,232 | \$1,284 | 68 |
| 24" | 24" | 5B-2424 | \$974 | \$1,039 | \$1,091 | 58 |
| 18" | 24" | 5B-1824 | \$914 | \$978 | \$1,030 | 48 |
| 18" | 18" | 5B-1818 | \$877 | \$942 | \$995 | 42 |

With Recessed Base - Black Standard

SHIPS FULLY ASSEMBLED

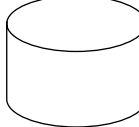

| D | W | Model # | Zone 0 | Zone 1 | Zone 2 | WT |
|---------|-----|---------|---------|---------|---------|----|
| 36" | 24" | 7F-3624 | \$1,070 | \$1,136 | \$1,188 | 66 |
| 30" | 24" | 7F-3024 | \$949 | \$1,015 | \$1,067 | 58 |
| 23 1/2" | 24" | 7F-2324 | \$707 | \$773 | \$825 | 52 |
| 20 1/2" | 24" | 7F-2024 | \$684 | \$748 | \$800 | 48 |
| 17 1/2" | 24" | 7F-1724 | \$647 | \$713 | \$765 | 44 |
| 36" | 30" | 7F-3630 | \$1,494 | \$1,560 | \$1,611 | 72 |
| 30" | 30" | 7F-3030 | \$1,240 | \$1,306 | \$1,358 | 65 |
| 23 1/2" | 30" | 7F-2330 | \$937 | \$1,002 | \$1,055 | 58 |
| 20 1/2" | 30" | 7F-2030 | \$914 | \$978 | \$1,030 | 53 |
| 17 1/2" | 30" | 7F-1730 | \$877 | \$942 | \$995 | 48 |

Without Recessed Base

SHIPS FULLY ASSEMBLED

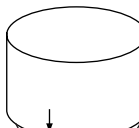

| D | W | Model # | Zone 0 | Zone 1 | Zone 2 | WT |
|---------|-----|---------|---------|---------|---------|----|
| 36" | 24" | 7B-3624 | \$1,398 | \$1,462 | \$1,514 | 74 |
| 30" | 24" | 7B-3024 | \$1,240 | \$1,306 | \$1,358 | 66 |
| 23 1/2" | 24" | 7B-2324 | \$937 | \$1,002 | \$1,055 | 61 |
| 20 1/2" | 24" | 7B-2024 | \$865 | \$930 | \$982 | 58 |
| 17 1/2" | 24" | 7B-1724 | \$816 | \$881 | \$934 | 54 |
| 36" | 30" | 7B-3630 | \$1,845 | \$1,909 | \$1,962 | 82 |
| 30" | 30" | 7B-3030 | \$1,518 | \$1,583 | \$1,635 | 74 |
| 23 1/2" | 30" | 7B-2330 | \$1,179 | \$1,244 | \$1,297 | 67 |
| 20 1/2" | 30" | 7B-2030 | \$1,107 | \$1,172 | \$1,224 | 62 |
| 17 1/2" | 30" | 7B-1730 | \$1,058 | \$1,123 | \$1,176 | 58 |

With Recessed Base - Black Standard

SHIPS FULLY ASSEMBLED

Note: Intermediate sizes available. Consult factory.

| | |
|--------------------|-----------|
| | Price |
| | Model # |
| Chrome Recess Base | CRB \$147 |
| Brass Recess Base | BRB \$147 |

Note: Pricing reflects up to 18" High. Specify required height ("H) in product description when ordering. 19" high to 24" add 15% to list price.

Classic 41



Triangle & Radius Triangle Tables

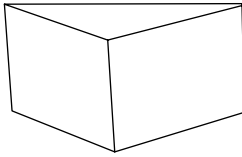

| | | 18" High | | | | |
|-----|-----|----------|--------|--------|--------|----|
| D | W | Model# | Zone 0 | Zone 1 | Zone 2 | WT |
| 16" | 16" | TR16-F | \$490 | \$555 | \$607 | 28 |
| 18" | 18" | TR18-F | \$502 | \$567 | \$619 | 30 |
| 24" | 24" | TR24-F | \$563 | \$627 | \$679 | 38 |
| 30" | 30" | TR30-F | \$647 | \$713 | \$765 | 54 |
| 36" | 36" | TR36-F | \$732 | \$797 | \$849 | 63 |
| 42" | 42" | TR42-F | \$853 | \$918 | \$970 | 78 |

Without Recessed Base

SHIPS FULLY ASSEMBLED

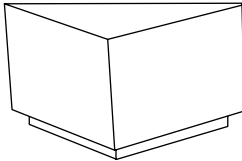

| | | 18" High | | | | |
|-----|-----|----------|---------|---------|---------|----|
| D | W | Model# | Zone 0 | Zone 1 | Zone 2 | WT |
| 16" | 16" | TR16-B | \$659 | \$725 | \$777 | 30 |
| 18" | 18" | TR18-B | \$696 | \$760 | \$813 | 32 |
| 24" | 24" | TR24-B | \$768 | \$834 | \$886 | 42 |
| 30" | 30" | TR30-B | \$914 | \$978 | \$1,030 | 59 |
| 36" | 36" | TR36-B | \$1,035 | \$1,099 | \$1,151 | 68 |
| 42" | 42" | TR42-B | \$1,191 | \$1,257 | \$1,309 | 85 |

With Recessed Base
Black Standard

SHIPS FULLY ASSEMBLED

NOTE: On the above tables, 2 of the 3 corners are blunt

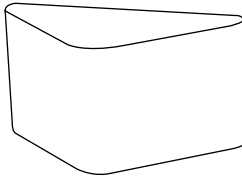

| | | 18" High | | | | |
|-----|-----|----------|---------|---------|---------|----|
| D | W | Model# | Zone 0 | Zone 1 | Zone 2 | WT |
| 18" | 18" | RTR-18F | \$732 | \$797 | \$849 | 30 |
| 24" | 24" | RTR-24F | \$840 | \$906 | \$958 | 38 |
| 30" | 30" | RTR-30F | \$914 | \$978 | \$1,030 | 54 |
| 36" | 36" | RTR-36F | \$1,022 | \$1,088 | \$1,139 | 63 |
| 42" | 42" | RTR-42F | \$1,131 | \$1,197 | \$1,248 | 78 |

Without Recessed Base

SHIPS FULLY ASSEMBLED

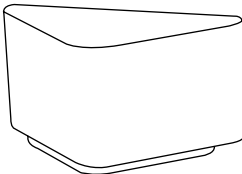

| | | 18" High | | | | |
|-----|-----|----------|---------|---------|---------|----|
| D | W | Model # | Zone 0 | Zone 1 | Zone 2 | WT |
| 18" | 18" | RTR-18B | \$998 | \$1,063 | \$1,116 | 32 |
| 24" | 24" | RTR-24B | \$1,107 | \$1,172 | \$1,224 | 42 |
| 30" | 30" | RTR-30B | \$1,252 | \$1,318 | \$1,369 | 59 |
| 36" | 36" | RTR-36B | \$1,373 | \$1,439 | \$1,490 | 68 |
| 42" | 42" | RTR-42B | \$1,530 | \$1,595 | \$1,647 | 85 |

With Recess Base
Black Standard

SHIPS FULLY ASSEMBLED

Optional: (In lieu of standard black)

| | | |
|--------------------|-----|-------|
| Chrome Recess Base | CRB | \$130 |
| Brass Recess Base | BRB | \$130 |

NOTE: The above are nominal dimensions.
Intermediate sizes available. Consult Factory

Classic 42



Classic Collection

Edge

Series 400 Conference Table Tops with 1 1/4" Vinyl Bumper Edge

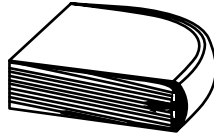

ROUND

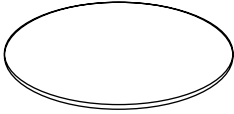

| DIA | Model # | Zone 0 | Zone 1 | Zone 2 | WT |
|-----|---------|--------|--------|--------|-----|
| 60" | 4TR60B | \$586 | \$652 | \$716 | 152 |
| 48" | 4TR48B | \$405 | \$471 | \$535 | 103 |
| 42" | 4TR42B | \$381 | \$446 | \$518 | 57 |
| 36" | 4TR36B | \$321 | \$386 | \$450 | 40 |
| 30" | 4TR30B | \$284 | \$350 | \$414 | 34 |

SQUARE

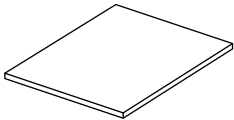

| D | W | Model # | Zone 0 | Zone 1 | Zone 2 | WT |
|-----|-----|---------|--------|--------|--------|----|
| 42" | 42" | 4TS42B | \$296 | \$362 | \$426 | 60 |
| 36" | 36" | 4TS36B | \$200 | \$265 | \$329 | 43 |

RECTANGULAR

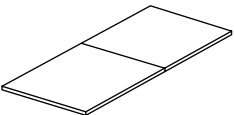

| D | W | Model # | Zone 0 | Zone 1 | Zone 2 | WT |
|-----|------|----------|---------|---------|---------|-----|
| 48" | 144" | 4T84B-RT | \$1,675 | \$1,704 | \$1,805 | 225 |
| 48" | 120" | 4T80B-RT | \$998 | \$1,159 | \$1,126 | 180 |
| 48" | 96" | 4T86B-RT | \$926 | \$990 | \$1,055 | 145 |
| 42" | 96" | 4T26B-RT | \$824 | \$842 | \$886 | 130 |
| 42" | 84" | 4T24B-RT | \$647 | \$713 | \$777 | 101 |
| 36" | 72" | 4T62B-RT | \$502 | \$567 | \$632 | 78 |
| 36" | 60" | 4T60B-RT | \$405 | \$471 | \$535 | 67 |
| 30" | 60" | 4T00B-RT | \$333 | \$397 | \$462 | 53 |

RACETRACK

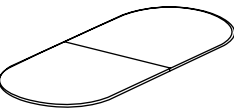

| D | W | Model # | Zone 0 | Zone 1 | Zone 2 | WT |
|-----|------|----------|---------|---------|---------|-----|
| 48" | 144" | 4T84B-OV | \$1,675 | \$1,741 | \$1,805 | 225 |
| 48" | 120" | 4T80B-OV | \$1,361 | \$1,426 | \$1,490 | 180 |
| 48" | 96" | 4T86B-OV | \$1,047 | \$1,112 | \$1,176 | 145 |
| 42" | 96" | 4T26B-OV | \$974 | \$1,039 | \$1,103 | 130 |
| 42" | 84" | 4T24B-OV | \$889 | \$955 | \$1,018 | 101 |
| 36" | 72" | 4T62B-OV | \$684 | \$748 | \$813 | 78 |
| 30" | 60" | 4T00B-OV | \$623 | \$688 | \$753 | 67 |

BOAT SHAPE

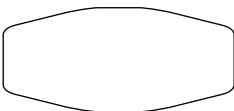

| D | W | Model # | Zone 0 | Zone 1 | Zone 2 | WT |
|-----|------|----------|---------|---------|---------|-----|
| 48" | 144" | 4T84B-BT | \$1,954 | \$2,019 | \$2,083 | 225 |
| 48" | 120" | 4T80B-BT | \$1,203 | \$1,269 | \$1,333 | 180 |
| 48" | 96" | 4T86B-BT | \$1,035 | \$1,099 | \$1,163 | 145 |
| 42" | 96" | 4T26B-BT | \$949 | \$1,015 | \$1,079 | 130 |
| 42" | 84" | 4T24B-BT | \$865 | \$930 | \$995 | 101 |
| 36" | 72" | 4T62B-BT | \$659 | \$725 | \$788 | 78 |
| 30" | 60" | 4T00B-BT | \$575 | \$639 | \$704 | 67 |

Note: All 120"W & 144"W tops will be in 2 -pieces with tight joint fastener

Classic 43



Classic Collection



Series 400 Conference Table Tops with 1 1/8" Self Edge

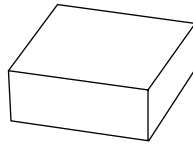

ROUND

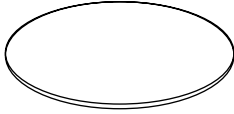

| DIA | Model # | Zone 0 | Zone 1 | Zone 2 | WT |
|-----|---------|--------|--------|--------|-----|
| 60" | 4TR60 | \$598 | \$664 | \$728 | 152 |
| 48" | 4TR48 | \$417 | \$483 | \$546 | 103 |
| 42" | 4TR42 | \$381 | \$446 | \$511 | 57 |
| 36" | 4TR36 | \$356 | \$422 | \$486 | 40 |
| 30" | 4TR30 | \$321 | \$386 | \$450 | 34 |

SQUARE

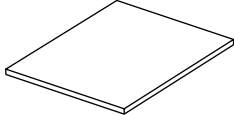

| D | W | Model # | Zone 0 | Zone 1 | Zone 2 | WT |
|-----|-----|---------|--------|--------|--------|----|
| 42" | 42" | 4TS42 | \$333 | \$397 | \$462 | 60 |
| 36" | 36" | 4TS36 | \$260 | \$325 | \$390 | 43 |

RECTANGULAR

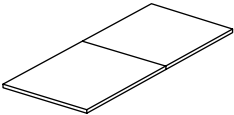

| D | W | Model # | Zone 0 | Zone 1 | Zone 2 | WT |
|-----|------|---------|---------|---------|---------|-----|
| 48" | 144" | 4T84-RT | \$1,724 | \$1,788 | \$1,853 | 225 |
| 48" | 120" | 4T80-RT | \$1,010 | \$1,076 | \$1,139 | 180 |
| 48" | 96" | 4T86-RT | \$961 | \$1,027 | \$1,091 | 145 |
| 42" | 96" | 4T26-RT | \$793 | \$858 | \$921 | 130 |
| 42" | 84" | 4T24-RT | \$684 | \$750 | \$813 | 101 |
| 36" | 72" | 4T62-RT | \$526 | \$592 | \$656 | 78 |
| 36" | 60" | 4T60-RT | \$465 | \$531 | \$571 | 67 |
| 30" | 60" | 4T00-RT | \$369 | \$434 | \$498 | 53 |

RACE TRACK

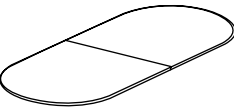

| D | W | Model # | Zone 0 | Zone 1 | Zone 2 | WT |
|-----|------|---------|---------|---------|---------|-----|
| 48" | 144" | 4T84-OV | \$2,014 | \$2,080 | \$2,144 | 225 |
| 48" | 120" | 4T80-OV | \$1,252 | \$1,318 | \$1,381 | 180 |
| 48" | 96" | 4T86-OV | \$1,035 | \$1,099 | \$1,163 | 145 |
| 42" | 96" | 4T26-OV | \$974 | \$1,039 | \$1,103 | 130 |
| 42" | 84" | 4T24-OV | \$889 | \$955 | \$1,018 | 101 |
| 36" | 72" | 4T62-OV | \$696 | \$760 | \$825 | 78 |
| 30" | 60" | 4T00-OV | \$514 | \$700 | \$765 | 67 |

BOAT SHAPE

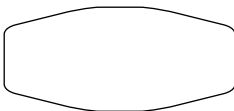

| D | W | Model # | Zone 0 | Zone 1 | Zone 2 | WT |
|-----|------|---------|---------|---------|---------|-----|
| 48" | 144" | 4T84-BT | \$2,026 | \$2,091 | \$2,156 | 225 |
| 48" | 120" | 4T80-BT | \$1,264 | \$1,293 | \$1,358 | 180 |
| 48" | 96" | 4T86-BT | \$1,022 | \$1,088 | \$1,151 | 145 |
| 42" | 96" | 4T26-BT | \$949 | \$1,015 | \$1,079 | 130 |
| 42" | 84" | 4T24-BT | \$865 | \$930 | \$995 | 101 |
| 36" | 72" | 4T62-BT | \$684 | \$748 | \$813 | 78 |
| 30" | 60" | 4T00-BT | \$611 | \$676 | \$740 | 67 |

Note: All 120"W & 144"W tops will be in 2 -pieces with tight joint fastener

Classic 44



Classic Collection



Series 400 Conference Table Tops 1 1/8" Wood Edge

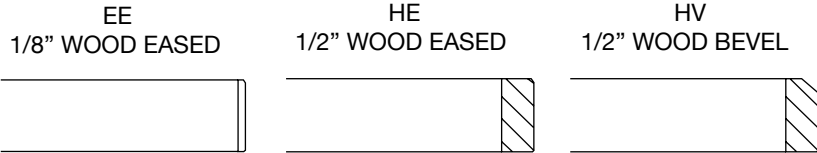

ROUND

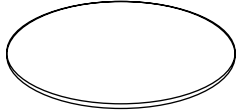

| | EE EDGE | HE EDGE | HV EDGE | Zone 0 | Zone 1 | Zone 2 | WT |
|-----|------------|-------------|------------|---------|---------|---------|-----|
| DIA | Model # | Model # | Model # | | | | |
| 60" | W4TR60B-EE | W4TR60MP-HE | W4TR60O-HV | \$1,641 | \$1,837 | \$2,065 | 152 |
| 48" | W4TR48B-EE | W4TR48MP-HE | W4TR48O-HV | \$1,191 | \$1,334 | \$1,494 | 103 |
| 42" | W4TR42B-EE | W4TR42MP-HE | W4TR42O-HV | \$1,034 | \$1,158 | \$1,297 | 57 |
| 36" | W4TR36B-EE | W4TR36MP-HE | W4TR36O-HV | \$833 | \$932 | \$1,044 | 40 |
| 30" | W4TR30B-EE | WRTR30MP-HE | W4TR30O-HV | \$732 | \$820 | \$918 | 34 |

SQUARE

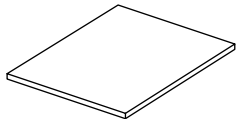

| | EE EDGE | HE EDGE | HV EDGE | Zone 0 | Zone 1 | Zone 2 | WT |
|-----|------------|-------------|------------|---------|---------|---------|----|
| D | Model # | Model # | Model # | | | | |
| 60" | W4TS42B-EE | W4TS42MP-HE | W4TS42O-HV | \$1,648 | \$1,846 | \$2,067 | 60 |
| 48" | W4TS36B-EE | W4TS36MP-HE | W4TS36O-HV | \$1,157 | \$1,295 | \$1,450 | 43 |

RECTANGULAR

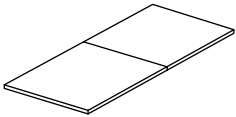

| | EE EDGE | HE EDGE | HV EDGE | Zone 0 | Zone 1 | Zone 2 | WT | |
|-----|------------|-------------|--------------|-------------|---------|---------|---------|-----|
| D | W | Model # | Model # | Model # | | | | |
| 48" | 144" | W4T84B-RTEE | W4T84MP-RTHE | W4T84O-RTHV | \$2,957 | \$3,312 | \$3,710 | 225 |
| 48" | 120" | W4T80B-RTEE | W4T80MP-RTHE | W4T80O-RTHV | \$2,516 | \$2,819 | \$3,158 | 180 |
| 48" | 96" | W4T86B-RTEE | W4T86MP-RTHE | W4T86O-RTHV | \$2,054 | \$2,300 | \$2,577 | 145 |
| 42" | 96" | W4T26B-RTEE | W4T26MP-RTHE | W4T26O-RTHV | \$2,054 | \$2,300 | \$2,577 | 130 |
| 42" | 84" | W4T24B-RTEE | W4T24MP-RTHE | W4T24O-RTHV | \$1,934 | \$2,165 | \$2,427 | 101 |
| 36" | 72" | W4T62B-RTEE | W4T62MP-RTHE | W4T62O-RTHV | \$1,277 | \$1,430 | \$1,602 | 78 |
| 36" | 60" | W4T60B-RTEE | W4T60MP-RTHE | W4T60O-RTHV | \$1,090 | \$1,220 | \$1,367 | 67 |
| 30" | 60" | W4T00B-RTEE | W4T00MP-RTHE | W4T00O-RTHV | \$946 | \$1,059 | \$1,187 | 53 |

RACETRACK

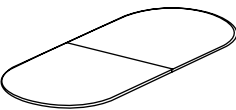

| | EE EDGE | HE EDGE | HV EDGE | Zone 0 | Zone 1 | Zone 2 | WT | |
|-----|------------|-------------|--------------|-------------|---------|---------|---------|-----|
| D | W | Model # | Model # | Model # | | | | |
| 48" | 144" | W4T84B-OVEE | W4T84MP-OVHE | W4T84O-OVHV | \$3,897 | \$4,364 | \$4,888 | 225 |
| 48" | 120" | W4T80B-OVEE | W4T80MP-OVHE | W4T80O-OVHV | \$3,307 | \$3,703 | \$4,147 | 180 |
| 48" | 96" | W4T86B-OVEE | W4T86MP-OVHE | W4T86O-OVHV | \$2,668 | \$2,987 | \$3,346 | 145 |
| 42" | 96" | W4T26B-OVEE | W4T26MP-OVHE | W4T26O-OVHV | \$2,668 | \$2,987 | \$3,346 | 130 |
| 42" | 84" | W4T24B-OVEE | W4T24MP-OVHE | W4T24O-OVHV | \$2,557 | \$2,864 | \$3,208 | 101 |
| 36" | 72" | W4T62B-OVEE | W4T62MP-OVHE | W4T62O-OVHV | \$1,828 | \$2,048 | \$2,293 | 78 |
| 30" | 60" | W4T00B-OVEE | W4T00MP-OVHE | W4T00O-OVHV | \$1,736 | \$1,944 | \$2,177 | 67 |

BOAT SHAPE

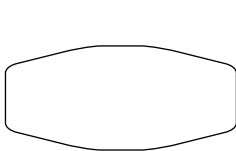

| | EE EDGE | HE EDGE | HV EDGE | Zone 0 | Zone 1 | Zone 2 | WT | |
|-----|------------|------------|------------|-----------|---------|---------|---------|-----|
| D | W | Model # | Model # | Model # | | | | |
| 48" | 144" | W4T84B-BT | W4T84MP-BT | W4T84O-BT | \$3,897 | \$4,364 | \$4,888 | 225 |
| 48" | 120" | W4T80B-BT | W4T80MP-BT | W4T80O-BT | \$3,307 | \$3,703 | \$4,147 | 180 |
| 48" | 96" | W4T86B-BT | W4T86MP-BT | W4T86O-BT | \$2,668 | \$2,987 | \$3,346 | 145 |
| 42" | 96" | W4T26B-BT | W4T26MP-BT | W4T26O-BT | \$2,668 | \$2,987 | \$3,346 | 130 |
| 42" | 84" | W4T24B-BT | W4T24MP-BT | W4T24O-BT | \$2,557 | \$2,864 | \$3,208 | 101 |
| 36" | 72" | W4T62B-BT | W4T62MP-BT | W4T62O-BT | \$1,828 | \$2,048 | \$2,293 | 78 |
| 30" | 60" | W4T00B-BT | W4T00MP-BT | W4T00O-BT | \$1,736 | \$1,944 | \$2,177 | 67 |

NOTE: All 120"W & 144"W tops will be in 2 - pieces with tight joint fastener

Classic 45



Classic Collection

Edge

Series 400 Conference Table Tops 1 1/8" Wood Edge

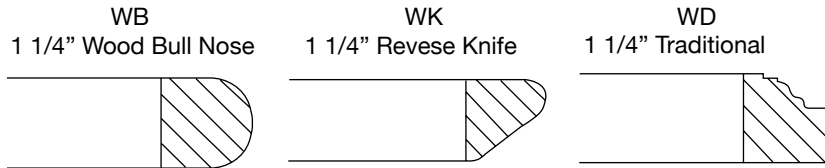

ROUND

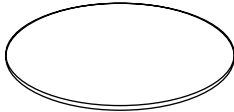

| DIA | WB EDGE | WK EDGE | WD EDGE | Zone 0 | Zone 1 | Zone 2 | WT |
|-----|------------|------------|-------------|---------|---------|---------|-----|
| | Model # | Model # | Model # | | | | |
| 60" | W4TR60W-WB | W4TR60M-WK | W4TR60CH-WD | \$1,881 | \$2,107 | \$2,360 | 152 |
| 48" | W4TR48W-WB | W4TR48M-WK | W4TR48CH-WD | \$1,540 | \$1,725 | \$1,932 | 103 |
| 42" | W4TR42W-WB | W4TR42M-WK | W4TR42CH-WD | \$1,313 | \$1,471 | \$1,647 | 57 |
| 36" | W4TR36W-WB | W4TR36M-WK | W4TR36CH-WD | \$1,137 | \$1,273 | \$1,426 | 40 |
| 30" | W4TR30W-WB | WRTR30M-WK | W4TR30CH-WD | \$1,044 | \$1,170 | \$1,310 | 34 |

SQUARE

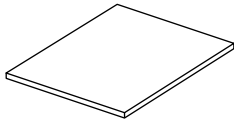

| D | WB EDGE | WK EDGE | WD EDGE | Zone 0 | Zone 1 | Zone 2 | WT |
|-----|------------|------------|-------------|---------|---------|---------|----|
| | Model # | Model # | Model # | | | | |
| 60" | W4TS42W-WB | W4TS42M-WK | W4TS42CH-WE | \$1,852 | \$2,075 | \$2,324 | 60 |
| 48" | W4TS36W-WB | W4TS36M-WK | W4TS36CH-WE | \$1,348 | \$1,510 | \$1,691 | 43 |

RECTANGULAR

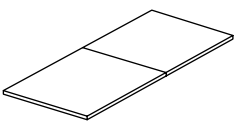

| D | W | WB EDGE | WK EDGE | WD EDGE | Zone 0 | Zone 1 | Zone 2 | WT |
|-----|------|-------------|-------------|--------------|---------|---------|---------|-----|
| | | Model # | Model # | Model # | | | | |
| 48" | 144" | W4T84W-RTWB | W4T84M-RTWK | W4T84CH-RTWD | \$3,181 | \$3,563 | \$3,991 | 225 |
| 48" | 120" | W4T80W-RTWB | W4T80M-RTWK | W4T80CH-RTWD | \$2,728 | \$3,055 | \$3,421 | 180 |
| 48" | 96" | W4T86W-RTWB | W4T86M-RTWK | W4T86CH-RTWD | \$2,267 | \$2,539 | \$2,844 | 145 |
| 42" | 96" | W4T26W-RTWB | W4T26M-RTWK | W4T26CH-RTWD | \$2,267 | \$2,539 | \$2,844 | 130 |
| 42" | 84" | W4T24W-RTWB | W4T24M-RTWK | W4T24CH-RTWD | \$2,120 | \$2,375 | \$2,660 | 101 |
| 36" | 72" | W4T62W-RTWB | W4T62M-RTWK | W4T62CH-RTWD | \$1,435 | \$1,608 | \$1,801 | 78 |
| 36" | 60" | W4T60W-RTWB | W4T60M-RTWK | W4T60CH-RTWD | \$1,234 | \$1,383 | \$1,550 | 67 |
| 30" | 60" | W4T00W-RTWB | W4T00M-RTWK | W4T00CH-RTWD | \$1,128 | \$1,263 | \$1,415 | 53 |

RACETRACK

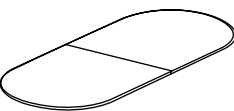

| D | W | WB EDGE | WK EDGE | WD EDGE | Zone 0 | Zone 1 | Zone 2 | WT |
|-----|------|-------------|-------------|--------------|---------|---------|---------|-----|
| | | Model # | Model # | Model # | | | | |
| 48" | 144" | W4T84W-OVWB | W4T84M-OVWK | W4T84CH-OVWD | \$4,131 | \$4,627 | \$5,182 | 225 |
| 48" | 120" | W4T80W-OVWB | W4T80M-OVWK | W4T80CH-OVWD | \$3,554 | \$3,982 | \$4,459 | 180 |
| 48" | 96" | W4T86W-OVWB | W4T86M-OVWK | W4T86CH-OVWD | \$2,849 | \$3,190 | \$3,573 | 145 |
| 42" | 96" | W4T26W-OVWB | W4T26M-OVWK | W4T26CH-OVWD | \$2,849 | \$3,190 | \$3,573 | 130 |
| 42" | 84" | W4T24W-OVWB | W4T24M-OVWK | W4T24CH-OVWD | \$2,615 | \$2,928 | \$3,279 | 101 |
| 36" | 72" | W4T62W-OVWB | W4T62M-OVWK | W4T62CH-OVWD | \$1,913 | \$2,142 | \$2,399 | 78 |
| 30" | 60" | W4T00W-OVWB | W4T00M-OVWK | W4T00CH-OVWD | \$1,755 | \$1,966 | \$2,201 | 67 |

BOAT SHAPE

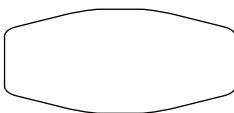

| D | W | WB EDGE | WK EDGE | WD EDGE | Zone 0 | Zone 1 | Zone 2 | WT |
|-----|------|-------------|-------------|--------------|---------|---------|---------|-----|
| | | Model # | Model # | Model # | | | | |
| 48" | 144" | W4T84W-BTWB | W4T84M-BTWK | W4T84CH-BTWD | \$4,131 | \$4,627 | \$5,182 | 225 |
| 48" | 120" | W4T80W-BTWB | W4T80M-BTWK | W4T80CH-BTWD | \$3,554 | \$3,982 | \$4,459 | 180 |
| 48" | 96" | W4T86W-BTWB | W4T86M-BTWK | W4T86CH-BTWD | \$2,849 | \$3,190 | \$3,573 | 145 |
| 42" | 96" | W4T26W-BTWB | W4T26M-BTWK | W4T26CH-BTWD | \$2,849 | \$3,190 | \$3,573 | 130 |
| 42" | 84" | W4T24W-BTWB | W4T24M-BTWK | W4T24CH-BTWD | \$2,615 | \$2,928 | \$3,279 | 101 |
| 36" | 72" | W4T62W-BTWB | W4T62M-BTWK | W4T62CH-BTWD | \$1,913 | \$2,142 | \$2,399 | 78 |
| 30" | 60" | W4T00W-BTWB | W4T00M-BTWK | W4T00CH-BTWD | \$1,755 | \$1,966 | \$2,201 | 67 |

NOTE: All 120"W & 144"W tops will be in 2 -pieces with tight joint fastener

Classic 46



Metal Bases

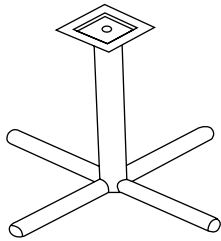

| Finish | Top Capacity | Base Spread | Model # | Zone 0 | Zone 1 | Zone 2 | WT |
|--------|--------------|-------------|---------|--------|--------|--------|----|
| Chrome | 42" Rd. | 32" x 32" | 5730-TC | \$589 | \$640 | \$701 | 24 |
| Chrome | 60" Rd. | 39" x 39" | 5736-TC | \$712 | \$769 | \$865 | 26 |
| Black | 42" Rd. | 32" x 32" | 5730-TB | \$556 | \$615 | \$661 | 24 |
| Black | 60" Rd. | 39" x 39" | 5736-TB | \$621 | \$637 | \$714 | 26 |

Cluster - 27 3/4" High

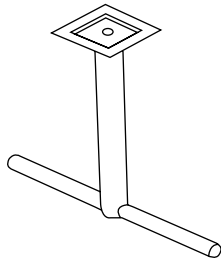

| WT | Finish | Top Capacity | Base Spread | Model # | Zone 0 | Zone 1 | Zone 2 |
|----|--------|--------------|-------------|-----------------|--------|--------|--------|
| 36 | Chrome | 36"D x 72"W | 26" | 5726-CC (pair) | \$573 | \$643 | \$713 |
| 42 | Chrome | 48"D x 96"W | 32" | 5736-CC* (pair) | \$599 | \$671 | \$751 |
| 36 | Black | 36"D x 72"W | 26" | 5726-CB (pair) | \$410 | \$460 | \$515 |
| 42 | Black | 48"D x 96"W | 32" | 5736-CB* (pair) | \$477 | \$535 | \$598 |

NOTE: Prices is for pair
Double Column base.*
Larger tops may need additional bases.

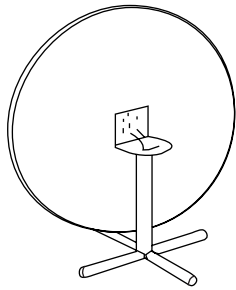

| Finish | Top Capacity | Model # | Zone 0 | Zone 1 | Zone 2 | WT |
|--------|--------------------|---------|--------|---------|---------|----|
| Chrome | 48" Rd. or 42" Sq. | FTC2 | \$822 | \$883 | \$944 | 26 |
| Chrome | 60" Rd. or 48" Sq. | FTC29 | \$947 | \$1,008 | \$1,068 | 26 |
| Black | 48" Rd. or 42" Sq. | FTB2 | \$811 | \$865 | \$932 | 26 |
| Black | 60" Rd. or 48" Sq. | FTB29 | \$924 | \$985 | \$1,045 | 26 |

Flip Top Base Unit

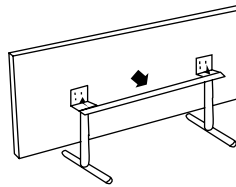

| Finish | Top Capacity | Model # | Zone 0 | Zone 1 | Zone 2 | WT |
|--------|--------------|---------|---------|---------|---------|-----|
| Chrome | 36"D x 72"W | FBC26 | \$1,107 | \$1,172 | \$1,237 | 105 |
| Chrome | 42"D x 72"W | FBC2 | \$1,119 | \$1,185 | \$1,248 | 115 |
| Black | 36"D x 72"W | FBCB26 | \$1,010 | \$1,076 | \$1,139 | 105 |
| Black | 42"D x 72"W | FBCB2 | \$1,070 | \$1,136 | \$1,200 | 115 |

Flip Top Base Unit with Handle

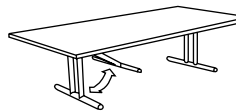

| Finish | Top Capacity | Model # | Zone 0 | Zone 1 | Zone 2 | WT |
|--------|-----------------------------|---------|--------|--------|--------|----|
| Chrome | 24"D x 64"W to 96"W | FDC24 | \$739 | \$827 | \$927 | 36 |
| Chrome | 30"D or 36"D x 64"W to 96"W | FDC30 | \$768 | \$860 | \$962 | 36 |
| Black | 24"D x 64"W to 96"W | FDB24 | \$581 | \$651 | \$729 | 36 |
| Black | 30"D or 36"D x 64"W to 96"W | FDB30 | \$648 | \$726 | \$813 | 36 |

Folding Table Base - Price is for PAIR
NOTE: Number of Vertical Columns varies with base sizes.

IMPORTANT: FOLDING MECHANISM REQUIRES TABLE TO BE AT 64" LONG IN ORDER TO FOLD PROPERLY

Classic 47



Laminate Bases

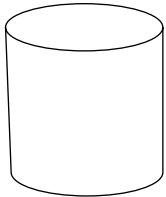

| Top Capacity | D | H | Model # | Zone 0 | Zone 1 | Zone 2 | WT |
|----------------|---------|---------|---------|---------|---------|---------|----|
| use w/ 60" Rd. | 30" | 27 3/4" | 4C30 | \$1,022 | \$1,076 | \$1,139 | 65 |
| use w/ 48" Rd. | 23 1/2" | 27 3/4" | 4C23 | \$974 | \$1,039 | \$1,091 | 58 |
| use w/ 42" Rd. | 20 1/2" | 27 3/4" | 4C20 | \$961 | \$1,027 | \$1,079 | 53 |
| use w/ 36" Rd. | 17 1/2" | 27 3/4" | 4C17 | \$926 | \$990 | \$1,042 | 43 |

Cylinder Base
NOTE: Tops Unfinished

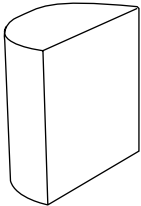

| Top Capacity | D | H | Model # | Zone 0 | Zone 1 | Zone 2 | WT |
|-----------------------------------|---------|---------|---------|---------|---------|---------|----|
| use w/ 42x 84 & 96 Oval Top Only | 20 1/2" | 27 3/4" | 4HC20 | \$696 | \$760 | \$813 | 30 |
| use w/ 42x 84 & 120 Oval Top Only | 23 1/2" | 27 3/4" | 4HC23 | \$719 | \$785 | \$837 | 40 |
| | 30" | 27 3/4" | 4HC30 | \$865 | \$930 | \$982 | 70 |
| | 36" | 27 3/4" | 4HC36 | \$1,047 | \$1,111 | \$1,163 | 90 |

Half Cylinder Base
NOTE: Tops Unfinished

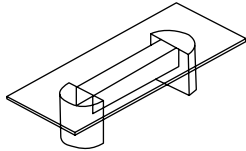

| W | Model # | Zone 0 | Zone 1 | Zone 2 | WT |
|-----|----------|---------|---------|---------|-----|
| 24" | STR4HC24 | \$1,787 | \$2,002 | \$2,242 | 240 |
| 30" | STR4HC30 | \$2,047 | \$2,292 | \$2,567 | 350 |
| 36" | STR4HC36 | \$2,371 | \$2,655 | \$2,973 | 425 |

Half Cylinder w/Stretcher

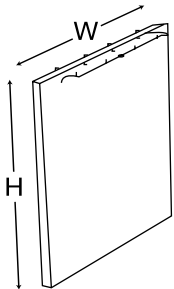

| W | Model # | Zone 0 | Zone 1 | Zone 2 | WT |
|-----|--------------|--------|--------|--------|----|
| 24" | 4PE24 (pair) | \$430 | \$495 | \$546 | 52 |
| 30" | 4PE30 (pair) | \$477 | \$543 | \$595 | 72 |
| 36" | 4PE36 (pair) | \$563 | \$627 | \$679 | 95 |

Base Panel Support

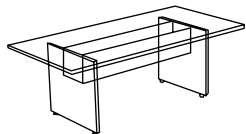

| W | Model # | Zone 0 | Zone 1 | Zone 2 | WT |
|-----|----------|---------|---------|---------|-----|
| 24" | STR4PE24 | \$1,269 | \$1,421 | \$1,592 | 208 |
| 30" | STR4PE30 | \$1,355 | \$1,518 | \$1,701 | 288 |
| 36" | STR4PE36 | \$1,436 | \$1,609 | \$1,803 | 380 |

End Panel w/Stretcher

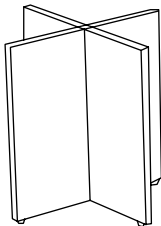

| W | Model # | Zone 0 | Zone 1 | Zone 2 | WT |
|-----|---------|--------|--------|--------|----|
| 24" | 4CB24 | \$575 | \$639 | \$691 | 52 |
| 30" | 4CB30 | \$635 | \$700 | \$753 | 72 |
| 36" | 4CB36 | \$696 | \$760 | \$813 | 95 |

Crossed Panel Base

Classic 48



Commercial Grade Cabinetry Cabinets, Counter, And Filler Specifications

- Healthcare
- Education
- Government
- Break rooms

Materials

Core Materials

1. Particle Board - Minimum Density 45 PCF, Industrial Grade 3 ply. max. moisture content 8%
2. Hardboard - Tempered smooth both sides.
3. Veneer Core Plywood

Face Materials

1. High Pressure Plastic Laminate: NEMA: LD3
 - a) General Purpose, 0.050 inch thick
 - b) Post Forming, 0.040 inch thick
 - c) Vertical Grade, 0.028 inch thick
 - d) Backer Sheet, 0.0020 inch thick

Edge Treatment Exposed and Semi -exposed Components

1. Body Members: Match face material, high pressure plastic laminate automatically applied using themofused glue.
2. Door and Drawer Fronts: Match face material, high pressure plastic laminate automatically applied using themofused glue.

Hardware

1. Hinges: High quality concealed cup hinge, 170 degrees opening and self closing.
2. Pulls: 4" on center wire pull. Brushed Aluminum standard finish.
3. Drawer Slides:
 - a) Cold rolled steel, epoxy coated, ball bearing roller slide.
 - b) Load Capacity, Typical Drawer 75 lbs. with 3/4 extensions.
4. Hardware for adjustable shelves
 - a) multiple holes 1 1/4 inch (32mm) on center with metal pins

Cabinet Construction Type

- A Flush Overlay

Core Material Thickness for Plastic Laminate Cad Components

- A Body Members, Rails: 3/4 inch thick particle board or veneer core plywood
- B Shelves: Particle Board or veneer core plywood
1. Spans up to 36 inches: 3/4 inch thick
 2. Interior shelves, white melamine with matching vinyl tape (Black available call customer service)
- C Backs: 1/4 inch hardboard, vinyl covered
- D Drawer Bottoms: 1/4 inch hardboard, vinyl covered
- E Drawer Sides, Backs, Sub fronts: 1/2" particleboard, min. density 50 pcf. vinyl wrapped
- F Drawer fronts, Doors: 3/4 particle board melamine interior, high pressure plastic laminate outside edges.

Surface Materials for Plastic Laminate

- A Exposed surfaces (other than edges): High pressure laminate 0.028" thick
- B Semi-exposed surfaces (other edges): High pressure laminate 0.028" thick, Clad Cabinets or low pressure laminate.
- C Countertops, Splashes, Edges: High pressure laminate 0.040" thick or 0.030" thick.

Assembly

- A. Casework shall be factory- assembled.



Classic Collection

Edge

Base Cabinets - 24" Depth - (Unfinished tops, sides, & backs)

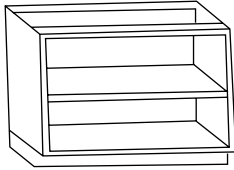

| W | H | Model # | Zone 0 | Zone 1 | Zone 2 | WT |
|-----|-----|---------|---------|---------|---------|-----|
| 24" | 30" | H1024 | \$623 | \$713 | \$861 | 81 |
| 30" | 30" | H1030 | \$805 | \$894 | \$1,042 | 101 |
| 36" | 30" | H1036 | \$986 | \$1,076 | \$1,224 | 122 |
| 24" | 36" | K1024 | \$684 | \$773 | \$921 | 92 |
| 30" | 36" | K1030 | \$877 | \$967 | \$1,116 | 115 |
| 36" | 36" | K1036 | \$1,070 | \$1,160 | \$1,321 | 138 |

No Door

SHIPS FULLY ASSEMBLED

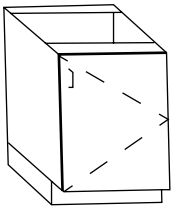

| W | H | Model # | Zone 0 | Zone 1 | Zone 2 | WT |
|-----|-----|---------|--------|--------|--------|----|
| 16" | 30" | H1116 | \$430 | \$518 | \$667 | 54 |
| 18" | 30" | H1118 | \$490 | \$579 | \$728 | 61 |
| 24" | 30" | H1124 | \$684 | \$773 | \$921 | 81 |
| 16" | 36" | K1116 | \$477 | \$567 | \$716 | 61 |
| 18" | 36" | K1118 | \$502 | \$627 | \$777 | 69 |
| 24" | 36" | K1124 | \$744 | \$834 | \$982 | 92 |

One Door

SHIPS FULLY ASSEMBLED

NOTE: Right Hinged (Specify "LEFT Hinged)

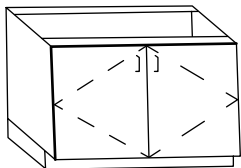

| W | H | Model # | Zone 0 | Zone 1 | Zone 2 | WT |
|-----|-----|---------|---------|---------|---------|-----|
| 30" | 30" | H1230 | \$877 | \$967 | \$1,116 | 101 |
| 36" | 30" | H1236 | \$1,070 | \$1,160 | \$1,309 | 122 |
| 30" | 36" | K1230 | \$949 | \$1,039 | \$1,188 | 115 |
| 36" | 36" | K1236 | \$1,156 | \$1,244 | \$1,393 | 138 |

Two Door

SHIPS FULLY ASSEMBLED

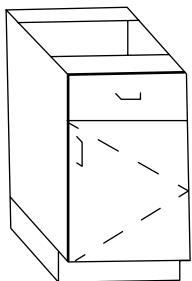

| W | H | Model # | Zone 0 | Zone 1 | Zone 2 | WT |
|-----|-----|---------|---------|---------|---------|----|
| 16" | 30" | H2316 | \$369 | \$459 | \$607 | 54 |
| 18" | 30" | H2318 | \$623 | \$713 | \$861 | 61 |
| 24" | 30" | H2324 | \$974 | \$1,063 | \$1,212 | 81 |
| 16" | 36" | K2316 | \$672 | \$760 | \$909 | 61 |
| 18" | 36" | K2318 | \$744 | \$834 | \$982 | 69 |
| 24" | 36" | K2324 | \$1,035 | \$1,123 | \$1,272 | 82 |

Drawer Over Door

SHIPS FULLY ASSEMBLED

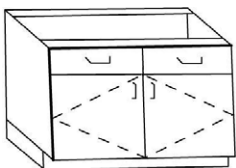

| W | H | Model # | Zone 0 | Zone 1 | Zone 2 | WT |
|-----|-----|---------|---------|---------|---------|-----|
| 30" | 30" | H2430 | \$930 | \$1,341 | \$1,490 | 101 |
| 36" | 30" | H2436 | \$1,136 | \$1,607 | \$1,756 | 122 |
| 30" | 36" | K2430 | \$1,337 | \$1,426 | \$1,596 | 115 |
| 36" | 36" | K2436 | \$1,615 | \$1,704 | \$1,853 | 138 |

Sink Base w/ Two Doors

SHIPS FULLY ASSEMBLED

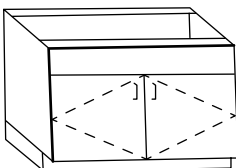

| W | H | Model # | Zone 0 | Zone 1 | Zone 2 | WT |
|-----|-----|---------|--------|---------|---------|-----|
| 30" | 30" | K3124 | \$768 | \$858 | \$1,007 | 101 |
| 36" | 30" | K3130 | \$949 | \$1,039 | \$1,188 | 122 |
| 30" | 36" | K3136 | \$865 | \$1,257 | \$1,405 | 115 |

NOTE: 30" H Units will have one adjustable shelf and 36" units will have two adjustable shelves. White interior finish standard. To have finish side on a cabinet specify RIGHT or LEFT and ADD \$193 to each LIST PRICE.

Classic 50



Classic Collection



Edge

Base Cabinets - 24" Depth - (Unfinished tops, sides, & backs)

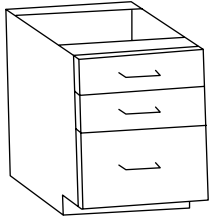

| W | H | Model # | Zone 0 | Zone 1 | Zone 2 | WT |
|-----|-----|---------|---------|---------|---------|-----|
| 16" | 30" | H2616 | \$865 | \$955 | \$1,103 | 97 |
| 18" | 30" | H2618 | \$974 | \$1,063 | \$1,212 | 109 |
| 24" | 30" | H2624 | \$1,337 | \$1,426 | \$1,575 | 127 |
| 30" | 30" | H2630 | \$1,700 | \$1,788 | \$1,938 | 145 |
| 36" | 30" | H2636 | \$2,050 | \$2,139 | \$2,289 | 163 |

Two 6" Drawers and One 12" Drawer
SHIPS FULLY ASSEMBLED

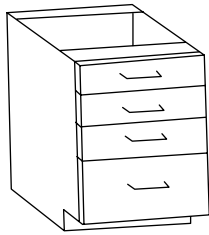

| W | H | Model # | Zone 0 | Zone 1 | Zone 2 | WT |
|-----|-----|---------|---------|---------|---------|-----|
| 16" | 36" | K2716 | \$1,022 | \$1,111 | \$1,260 | 108 |
| 18" | 36" | K2718 | \$1,156 | \$1,244 | \$1,393 | 125 |
| 24" | 36" | K2724 | \$1,579 | \$1,668 | \$1,817 | 135 |
| 30" | 36" | K2730 | \$1,987 | \$2,079 | \$2,228 | 156 |
| 36" | 36" | K2736 | \$2,413 | \$2,502 | \$2,651 | 176 |

Three 6" Drawers and One 12" Drawer
SHIPS FULLY ASSEMBLED

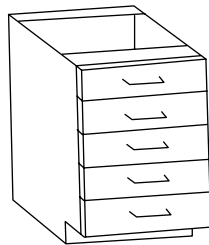

| W | H | Model # | Zone 0 | Zone 1 | Zone 2 | WT |
|-----|-----|---------|---------|---------|---------|-----|
| 16" | 36" | K2816 | \$1,156 | \$1,244 | \$1,393 | 108 |
| 18" | 36" | K2818 | \$1,288 | \$1,378 | \$1,526 | 125 |
| 24" | 36" | K2824 | \$1,712 | \$1,801 | \$1,949 | 135 |
| 30" | 36" | K2830 | \$2,123 | \$2,212 | \$2,361 | 156 |
| 36" | 36" | K2836 | \$2,547 | \$2,635 | \$2,784 | 184 |

Five 6" Drawers
SHIPS FULLY ASSEMBLED

NOTE: To have finished side on cabinet specify RIGHT or LEFT
and **ADD \$165 to EACH LIST PRICE**

Base Cabinet Panels / Fillers

| W | Model # | Zone 0 | Zone 1 | Zone 2 | WT |
|----|---------|--------|--------|--------|----|
| 2" | Q952 | \$114 | \$144 | \$160 | 5 |
| 6" | Q956 | \$139 | \$168 | \$184 | 7 |

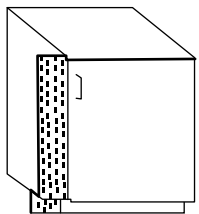

Filler Strip

| Model # | Zone 0 | Zone 1 | Zone 2 | WT |
|---------|--------|--------|--------|----|
| Q98CT | \$163 | \$192 | \$208 | 9 |

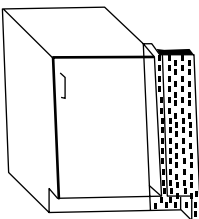

Corner Toe

NOTE: Panels and Fillers are for field installation

Classic 51



Classic Collection

Edge

Wall Cabinets - 12" Depth - (unfinished top and sides)

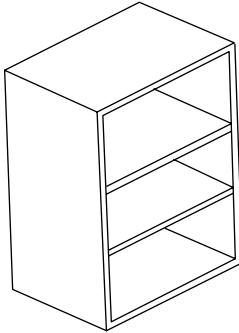

| W | H | Model # | Zone 0 | Zone 1 | Zone 2 | WT |
|-----|-----|---------|--------|--------|--------|----|
| 16" | 30" | D1016 | \$321 | \$410 | \$558 | 37 |
| 18" | 30" | D1018 | \$369 | \$458 | \$607 | 41 |
| 24" | 30" | D1024 | \$490 | \$579 | \$728 | 55 |
| 30" | 30" | D1030 | \$635 | \$725 | \$873 | 69 |
| 16" | 36" | F1016 | \$345 | \$434 | \$583 | 44 |
| 18" | 36" | F1018 | \$356 | \$446 | \$595 | 50 |
| 24" | 36" | F1024 | \$575 | \$664 | \$813 | 60 |
| 30" | 36" | F1030 | \$719 | \$809 | \$897 | 75 |

No doors

SHIPS FULLY ASSEMBLED

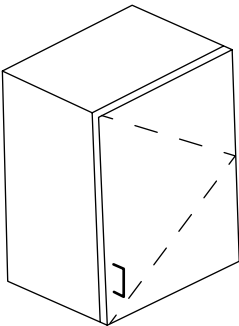

| W | H | Model # | Zone 0 | Zone 1 | Zone 2 | WT |
|-----|-----|---------|--------|--------|--------|----|
| 16" | 30" | D1116 | \$393 | \$483 | \$632 | 37 |
| 18" | 30" | D1118 | \$442 | \$531 | \$679 | 41 |
| 24" | 30" | D1124 | \$623 | \$713 | \$861 | 55 |
| 16" | 36" | F1116 | \$430 | \$518 | \$667 | 44 |
| 18" | 36" | F1118 | \$490 | \$579 | \$728 | 50 |
| 24" | 36" | F1124 | \$684 | \$773 | \$921 | 66 |

One Door

NOTE: Right Hinged (Specify "LEFT Hinged")

SHIPS FULLY ASSEMBLED

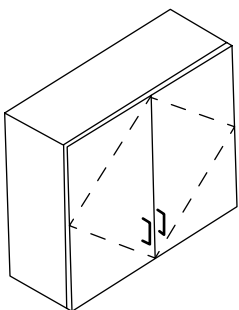

| W | H | Model # | Zone 0 | Zone 1 | Zone 2 | WT |
|-----|-----|---------|---------|---------|---------|----|
| 30" | 30" | D1230 | \$793 | \$881 | \$1,030 | 69 |
| 36" | 30" | D1236 | \$961 | \$1,051 | \$1,200 | 83 |
| 30" | 36" | F1230 | \$877 | \$967 | \$1,116 | 83 |
| 36" | 36" | F1236 | \$1,082 | \$1,172 | \$1,321 | 99 |

NOTE: 30" H Units will have one adjustable shelf and 36" units will have two adjustable shelves. White interior finish standard. To have finish side on a cabinet specify RIGHT or LEFT and ADD \$146 to each LIST PRICE.

Classic 52



Classic Collection



Edge

Wall Cabinets - Panels/Fillers

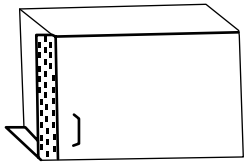

| H | Model# | Zone 0 | Zone 1 | Zone 2 | WT |
|-----|--------|--------|--------|--------|----|
| 30" | Q9030 | \$103 | \$132 | \$160 | 5 |
| 36" | Q9036 | \$114 | \$144 | \$172 | 7 |

Filler Strips - 2"W

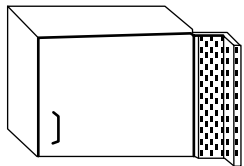

| H | Model# | Zone 0 | Zone 1 | Zone 2 | WT |
|-----|--------|--------|--------|--------|----|
| 30" | Q9330 | \$114 | \$144 | \$172 | 7 |
| 36" | Q9336 | \$127 | \$156 | \$208 | 9 |

Corner -2" x 2"

Counter Tops

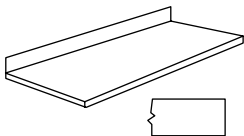

| 25"D Model# | Zone 0 | Zone 1 | Zone 2 | WT |
|-------------|--------|--------|--------|------|
| W25-B | \$114 | \$144 | \$172 | 13FT |

Flat Edge w/ Backsplash 4"H

NOTE: Price is per foot

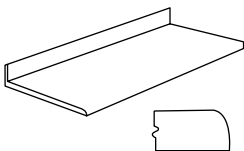

| 25"D Model# | Zone 0 | Zone 1 | Zone 2 | WT |
|-------------|--------|--------|--------|------|
| X25-B | \$151 | \$180 | \$208 | 13FT |

Waterfall Edge w/ Backsplash 4"H

NOTE: Price is per foot

NOTE: Panels and Fillers are field installation.

Classic 53



Tall Cabinets - 84" High (Unfinished Tops, Sides & back)

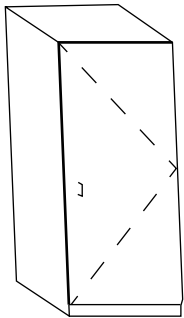

| | | 24"D | | | | |
|-----|--------|---------|---------|---------|-----|--|
| W | Model# | Zone 0 | Zone 1 | Zone 2 | WT | |
| 16" | P1116 | \$2,098 | \$2,188 | \$2,337 | 92 | |
| 18" | P1118 | \$2,413 | \$2,502 | \$2,651 | 104 | |
| 24" | P1124 | \$3,236 | \$3,325 | \$3,474 | 138 | |

One Door, 1 Stationary Shelf, 4 adjustable Shelves
SHIPS FULLY ASSEMBLED

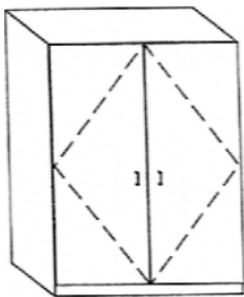

| | | 24"D | | | | |
|-----|--------|---------|---------|---------|-----|--|
| W | Model# | Zone 0 | Zone 1 | Zone 2 | WT | |
| 30" | P1230 | \$3,272 | \$3,361 | \$3,510 | 173 | |
| 36" | P1236 | \$3,938 | \$4,026 | \$4,175 | 207 | |

Two Door, 1 Stationary Shelf, 4 adjustable Shelves
SHIPS FULLY ASSEMBLED

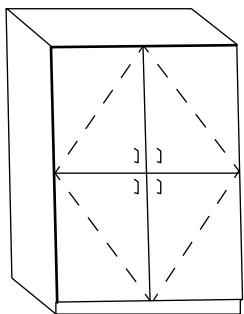

| | | 24"D | | | | |
|-----|--------|---------|---------|---------|-----|--|
| W | Model# | Zone 0 | Zone 1 | Zone 2 | WT | |
| 30" | P8330 | \$3,357 | \$3,446 | \$3,595 | 173 | |
| 36" | P8336 | \$4,010 | \$4,100 | \$4,248 | 207 | |

Double Doors over Double Doors, 1 Stationary Shelf, 4 adjustable shelves
SHIPS FULLY ASSEMBLED

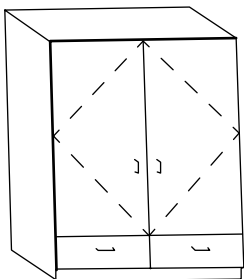

| | | 24"D | | | | |
|-----|--------|---------|---------|---------|-----|--|
| W | Model# | Zone 0 | Zone 1 | Zone 2 | WT | |
| 30" | P8530 | \$3,804 | \$3,893 | \$4,042 | 173 | |
| 36" | P8536 | \$4,590 | \$4,680 | \$4,829 | 207 | |

Doors Over Drawers
3 Adjustable Shelves
SHIPS FULLY ASSEMBLED

NOTE: All one door cabinets standard hinged right unless LEFT is specified.
Lock on door - Add \$118 to LIST PRICE
To have finished side on cabinet specify **LEFT** or **RIGHT**
Add \$247 to EACH LIST PRICE

Classic 54



Classic Collection

Edge

Series 1100 DVD Cabinets

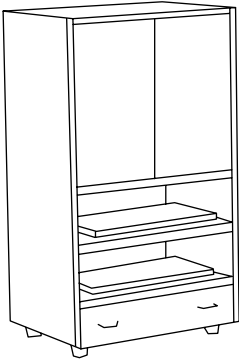

| W | D | H | Model | Zone 0 | Zone 1 | Zone 2 | WT |
|-----|-----|---------|--------|---------|---------|---------|-----|
| 36" | 25" | 62 1/2" | 11TV01 | \$3,877 | \$3,966 | \$4,115 | 482 |

2 Pocket Doors/ 2 Shelves w/ Pull out Pad - 1 Bottom Drawer

NOTE: Inside Clearance on Cabinets

TOP: 28"W x 27" 23"D

BOTTOM: 33 1/2"W x 28 5/8"H x 23"D

SHIPS FULLY ASSEMBLED

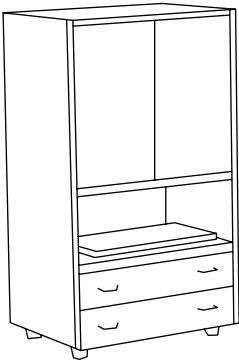

| W | D | H | Model | Zone 0 | Zone 1 | Zone 2 | WT |
|-----|-----|---------|--------|---------|---------|---------|-----|
| 36" | 25" | 62 1/2" | 11TV02 | \$3,610 | \$3,700 | \$3,849 | 482 |

2 Pocket Doors/ 2 Shelves w/ Pull out Pad - 1 Bottom Drawer

NOTE: Inside Clearance on Cabinets

TOP: 28"W x 27" 23"D

BOTTOM: 33 1/2"W x 28 5/8"H x 23"D

SHIPS FULLY ASSEMBLED

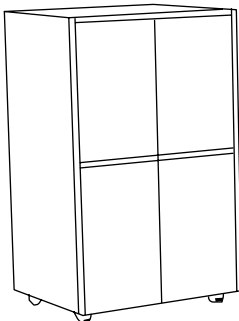

| W | D | H | Model | Zone 0 | Zone 1 | Zone 2 | WT |
|-----|-----|---------|--------|---------|---------|---------|-----|
| 36" | 25" | 62 1/2" | 11TV03 | \$4,397 | \$4,486 | \$4,635 | 425 |

2 Pocket Doors/ 2 Shelves w/ Pull out Pad - 1 Bottom Drawer

2 Hinged Doors w/Adjustable Shelf Bottom

NOTE: Inside Clearance on Cabinets

TOP: 28"W x 27" 23"D

BOTTOM: 33 1/2"W x 28 5/8"H x 23"D

SHIPS FULLY ASSEMBLED

Classic 55

NOTE: LOCKS FOR EACH SET OF DOORS - ADD \$132 to LIST



Classic Collection



Edge

Visual Board and Lecterns

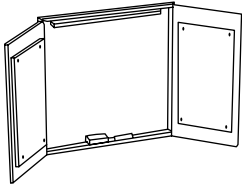

| W | D | H | Model | Zone 0 | Zone 1 | Zone 2 | WT |
|---------|----|---------|-------|---------|---------|---------|-----|
| 47 1/4" | 5" | 47 3/4" | VSB1 | \$2,510 | \$2,598 | \$2,749 | 135 |

Visual Board w/porcelain dry ease surface and laminate doors with tackpanel on interior doors.

NOTE: Visual Board come standard with Dry Erase Makers, Eraser Kit, and PULL Down Screen. (Pull Down Screen not required, deduct \$348 from LIST PRICE)

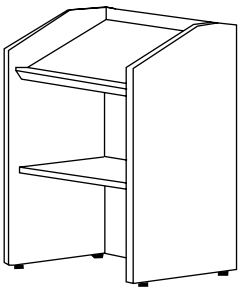

| W | D | H | Model | Zone 0 | Zone 1 | Zone 2 | WT |
|-----|-----|-----|--------|---------|---------|---------|-----|
| 24" | 18" | 48" | 11EC-F | \$1,167 | \$1,257 | \$1,405 | 102 |

Full Height Lectern

SHIPS FULLY ASSEMBLED

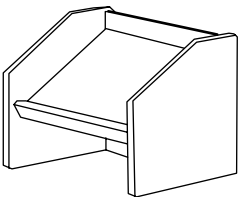

| W | D | H | Model | Zone 0 | Zone 1 | Zone 2 | WT |
|-----|-----|-----|--------|--------|--------|---------|-----|
| 24" | 18" | 15" | 11EC-T | \$611 | \$918 | \$1,070 | 102 |

Table Top Lectern

SHIPS FULLY ASSEMBLED

NOTE: Lecterns are vinyl bumper edge

Classic 56



Classic Collection



Edge

Study Carrels

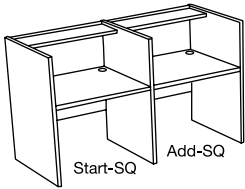

| W | D | H | Model | Zone 0 | Zone 1 | Zone 2 | WT |
|-----|---------|-----|----------|---------|---------|---------|-----|
| 30" | 36" | 48" | START-SQ | \$1,615 | \$1,704 | \$1,857 | 216 |
| 30" | 34 3/4" | 48" | ADD-SQ | \$1,277 | \$1,365 | \$1,514 | 171 |

Starter Station w/ Add -On Square Profile

NOTE: Cable cut-outs standard **RIGHT & LEFT**

Starter Units are drilled & pinned on LEFT & RIGHT sides.

Work surface 29"High

Bookshelf is 4" from the top of carrel

Task light is available. Consult Customer Service

Ships Knocked Down

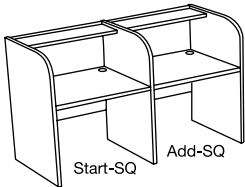

| W | D | H | Model | Zone 0 | Zone 1 | Zone 2 | WT |
|-----|---------|-----|----------|---------|---------|---------|-----|
| 30" | 36" | 48" | START-RD | \$1,784 | \$1,874 | \$2,023 | 216 |
| 30" | 34 3/4" | 48" | ADD-RD | \$1,398 | \$1,486 | \$1,635 | 171 |

Starter Station w/ Add -On Square Profile

NOTE: Cable cut-outs standard **RIGHT & LEFT**

Starter Units are drilled & pinned on LEFT & RIGHT sides.

Work surface 29"High

Bookshelf is 4" from the top of carrel

Task light is available. Consult Customer Service

Ships Knocked Down

Classic 57



Classic Collection



Optional Accessories for Curved Desks

Centered Drawer

Sized per unit - Must specify location - CD - \$216

NOTE: Pricing based ordering with a desk. If ordering a Center Drawer only consult Customer Service

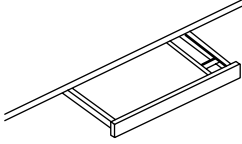

Storage Pedestal

Under curved desks 18" Deep model.

Under returns use 18" Deep model.

(Refer to page for pricing)

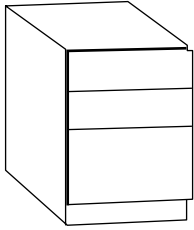

Cable Cut-Outs

Available in black only. 2 3/8" Diameter with cover.

1CO - \$71 ea

(Specify locations)

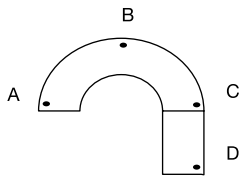

Optional Accessories for Reception Desk

Centered Drawer

Sized per unit - Must specify location - CD - \$216

NOTE: Pricing based ordering with a desk. If ordering a Center Drawer only consult Customer Service

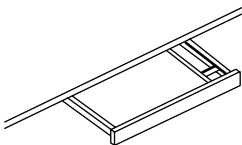

Box, Box, File

Pedestal mounted in desk.

Specify LEFT hand (LH) or **RIGHT** hand (RH) installation.

24"H x 22"D x 16"W with LOCK

BBF/L - \$906

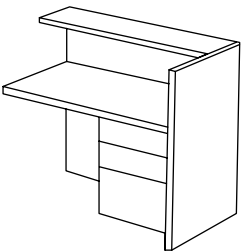

Classic 58



Optional Accessories for Reception Desk

File, File

Pedestal mounted in desk.
Specify **LEFT** hand (LH) or **RIGHT** hand (RH) installation.
24”H x 22”D x 16”W with LOCK
FF/L - \$906

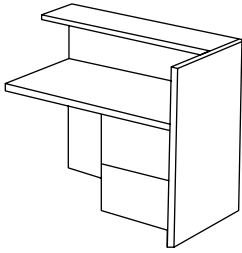

Box, File

Pedestal mounted in desk.
Specify **LEFT** hand (LH) or **RIGHT** hand (RH) installation.
18”H x 18”D x 16”W with LOCK
BF/L - \$724

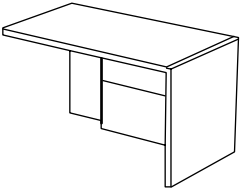

Task Light

If task light not required - TL \$237 (deduct)

Optional Accessories for Momentum Curved Desk

Centered Drawer

Sized per unit - Must specify location
CD - \$216 (Note: Pricing based ordering with a desk. If ordering a Center Drawer only consult Customer Service)

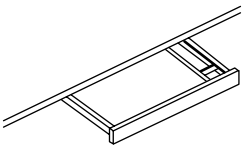

Storage Pedestal

Under curved desks 18” Deep model
Under returns use 18” Deep model.
(Refer to pages 24-25 for pricing)

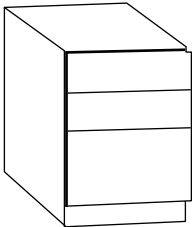

Cable Cut-Outs

Available in black only. 2 3/8” Diameter with cover. (Specify locations)
1CO - \$71 ea

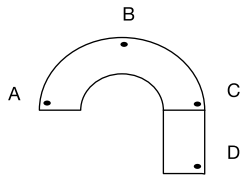



Classic Collection



Optional Accessories for Momentum Reception Desks

Center Drawer

Sized per unit - Must specify location - **CD - \$216**

NOTE: Pricing based ordering with a desk. If ordering a Center Drawer only consult Customer Service

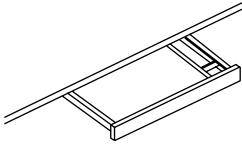

Box, Box, File

Pedestal mounted in desk.

Specify **LEFT** hand (LH) or **RIGHT** hand (RH) installation.
24"H x 22"D x 16"W with LOCK

BBF/L - \$1,293

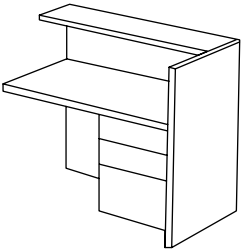

File, File

Pedestal mounted in desk.

Specify **LEFT** hand (LH) or **RIGHT** hand (RH) installation.
18"H x 18"D x 16"W with LOCK

BBF/L - \$1,293

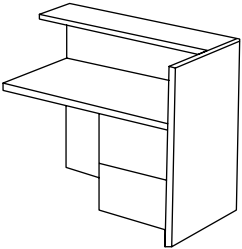

Box, File

LEFTRIGHT

BF/L - \$1,039

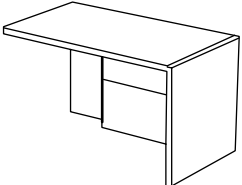

Task Light

If task light not required - TL \$216 (deduct)

Classic 60



Optional Accessories for Casegoods

Center Drawer

Sized per unit - Must specify location - **CD - \$216**

NOTE: Pricing based ordering with a desk. If ordering a Center Drawer only consult Customer Service
Cable Cut Out w/ Cover



2COL - \$71

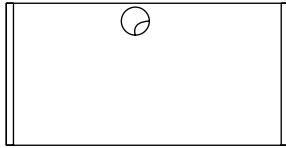

2CO - \$71



2COR - \$71

Master Key for Multiple Units

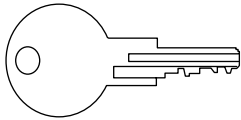

MK-\$56

Sliding Keyboard

SKS-\$273

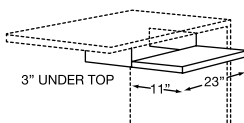

NOTE: If under return with pedestal, use 49" or larger return.
Not recommended for use with 26"H units.

Articulating Keyboard

AKB-\$706

The keyboard pad measures 9"D x 24"W

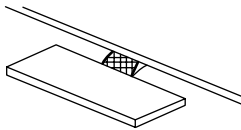

Optional Accessories for Casegoods

Printer Grommet

Specify location. Consult factory.

Shelf Available for Under Work Surface

Consult factory

Counter Weight for Laterals

CWT -\$144

Lock for Flipper Doors

2FL-\$120 (per door)

J-Track Molding

| | Zone 0 | Zone 1 | Zone 2 |
|---------------|--------|--------|--------|
| JT-2" Lengths | \$70 | \$79 | \$84 |
| JT-4 Lengths | \$92 | \$103 | \$111 |
| JT-5"-Lengths | \$105 | \$118 | \$130 |
| JT-6"-Lengths | \$121 | \$134 | \$148 |

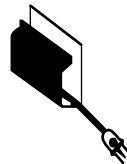

Tasklight

| | | Zone 0 | Zone 1 | Zone 2 |
|---------|---------------|--------|--------|--------|
| TL - 24 | 24" Tasklight | \$251 | \$282 | \$308 |
| TL - 48 | 48" Tasklight | \$391 | \$441 | \$480 |



TERMS

1. TERMS of PAYMENT

NET 15 days from date of shipment. Penalty 1/2% past due amount per month beyond 30 days from shipping date. Terms of payment will apply unless modified in writing by L.U.I.+PLUS.

2. PRICES

All pricing is LIST including delivery to one destination with a minimum. **Orders \$4,000.00 NET or more will ship freight PAID to one destination. Orders under \$4,000.00 NET will be charged a flat freight fee of \$300.00.** Pricing is for **DOCK to DOCK** delivery to a business. Any CALL **BEFORE / b4 DELIVERY CHARGES** from carriers will be add **\$25.00** to customer invoice. These published prices are effective by date shown and supercede previously publishing pricing. All pricing for shipments in the Continental United States delivered by the carrier of choice. Please consult factory for orders with destinations not shown on chart.

3. ORDER ENTRY

A. Written Orders must be accompanied by the customer's Purchase Order number and /or formal Purchase Order.

B. Orders will be accepted over FAX machine and or email as formal purchase orders. Confirmation not necessary. Duplicate orders not marked "**CONFIRMATION**" are the responsibility of the customer's. **FAX number: 1-(812) 482-1986.**

Order Email: luispang@psci.net.

C. Preliminary Orders - A preliminary order is a firm order submitted to L.U.I.+PLUS which lacks the complete information required to proceed with the order, such as: size, color of, or choice of material, etc. Preliminary orders will be governed by all standard Terms and Conditions of Sale. Preliminary Orders must include a requested ship date. We may acknowledge preliminary orders with a tentative ship date and at the time of acknowledgement will specify a date by which this information must be received in order to meet the acknowledged ship date. If this information is not received by the date specified, the order will be rescheduled to a later date and reacknowledge accordingly by L.U.I.+PLUS due to the non performance of the customer in supplying the information required by L.U.I.+PLUS will be subject to the pricing policy in effect at time of shipment.

D. Repair/Replacement orders for freight damaged parts or units must be ordered on a purchase order. No verbal orders taken. Pictures / Photos must be submitted.

E. Order cancellations are subject to a charge of 50% of the total NET bill of materials plus any charges that have accrued through manufacture or purchase of special materials. Should L.U.I.+PLUS agree to restock any QUICK SHIP ITEM, there will be a 60% restocking charge. Shipping point and date may be changed only if confirmed L.U.I.+PLUS at least one (1) week prior to schedule ship date. Storage charges will be assessed on customer delayed shipments.

F. Order Acknowledgements will be made by mail or fax or emailed to the customer. The customer will receive an acknowledgement. It is the customer's responsibility to review this acknowledgement carefully to see that it is correct in regard to the bill of materials, pricing, shipping address and in all other respects.

G. When the purchase order is received & model numbers & description do not match, model number will take precedent.

H. Revisions, Additions, and / or Deletions to an Order will be accepted if confirmed by L.U.I.+PLUS. Additions to in-house orders will be accepted at the same pricing as the original order and to the same address. Certain revisions to orders may affect delivery and pricing.

4. TAXES

All taxes are responsibility of the customer and are not included in our pricing. It is the customer's responsibility to provide L.U.I.+PLUS with appropriate TAX NUMBERS / TAX EXEMPT CERTIFICATE at time of order entry; otherwise tax will be applied, as required.

5. MINIMUM ORDERS

The minimum order that will be accepted is \$100.00 NET. Orders for less than \$100.00 NET will be billed \$100.00

6. CLAIMS

All merchandise is turned over to the transporting carrier in good condition and our liability for damages ceases at that time. Packing is transit tested. Shipments received short or damaged should be NOTED on the freight bill before signing for merchandise. All claims must be settled with the transportation company. File all claims promptly. L.U.I.+PLUS will not be responsible for any repairs resulting from transit damage.

7. PREDECE of TERMS AND CONDITIONS

These terms and conditions of the Price List and L.U.I.+PLUS Order Acknowledgement Conditions supersede and take precedence over the buyer's terms and conditions as stated on his/her purchase order, unless agreed otherwise in writing. The entering of an order to L.U.I.+PLUS shall acknowledge this concurrence.

8. PRODUCT CHANGES

In accordance with its policy of continuing product system improvement, L.U.I.+PLUS reserves the right to change, engineering, design or specifications without incurring obligation or liability and without further notice. Any product discontinued by L.U.I.+PLUS will be made available only for a period of one (1) year after date of product cancellation.

9. WEIGHTS

All weights are approximate & should be used only as a guide.

10 YEAR WARRANTY

Material and factory workmanship of standard L.U.I.+PLUS products are warranted for a period of 10 years from the the date of shipment from our factory (unless otherwise stated in writing), provided they are installed in accordance with L.U.I.+PLUS recommended installation procedures and cleaning instructions.

